

User Manual

pE-800

8-channel LED illumination

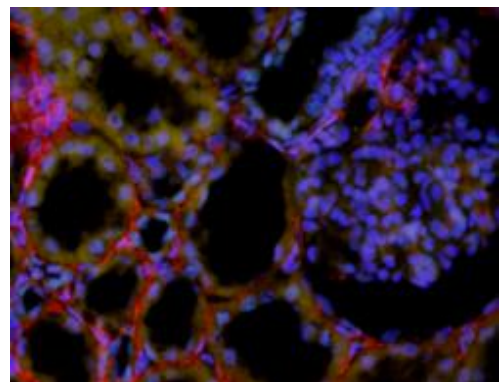

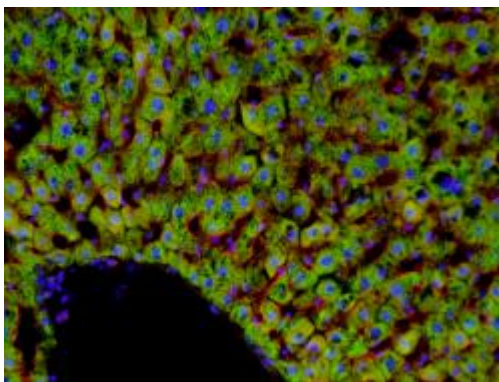
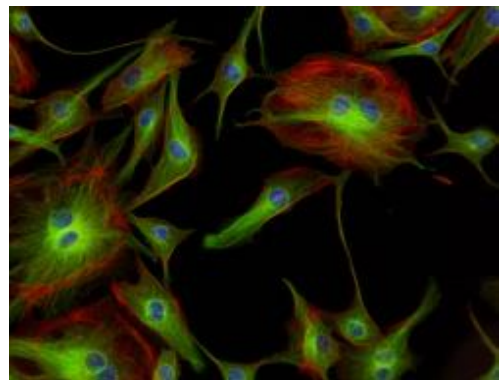
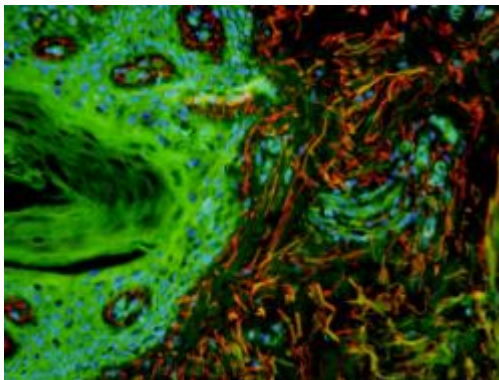
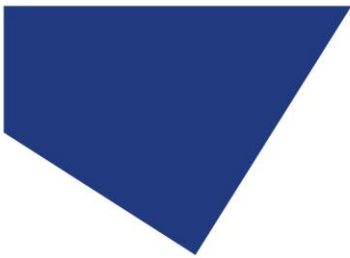

Contents

1. Introduction	3
2. Safety Precautions	3
3. Getting Started – System Components.....	6
4. Installation and Setup	7
5. pE-800 LEDs overview	10
6. Control Overview	11
7. LightBridge – Standard/TTL mode	15
8. LightBridge – Analogue Mode.....	18
9. LightBridge – Sequence Runner Mode	19
10. LightBridge – Demo Mode	23
11. LightBridge – Additional settings	28
12. Fitting Excitation Filters.....	37
13. Software updates	41
14. Additional information.....	44
15. Product Specifications.....	45
16. Product Options and Order Codes.....	45
17. Warranty and Repairs	46
18. Compliance and Environmental.....	46
19. Contact Details	47
20. Appendix 1	48

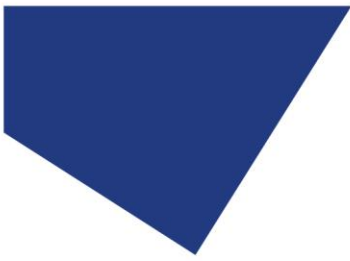

1. Introduction

This manual should give you all the information required to install and operate your new light source.

Additional information can be found on our website at www.cooled.com.

2. Safety Precautions

While LEDs are a much safer illumination system than the mercury and metal halide lamps that they replace in microscopy applications, precautions should still be taken with this product.

When operating or maintaining this product, please observe the following safety precautions at all times. Failure to do so may result in personal injury or damage to other items.

Please ensure that only the power supply and cord supplied are used with this equipment.

The AC cord supplied with this Light Source must only be used with the equipment supplied.

2.1.

UV light may be emitted from this product depending on the version/wavelength selected. Avoid eye and skin exposure. Never look directly into the light output beam from the Light Source or accessories. The emissions could damage the cornea and retina of the eye if the light is observed directly.

2.2.

Always ensure that the Light Source is securely attached to the microscope (either directly or with a liquid light guide and collimator, depending on the version) prior to turning on the power. This will minimise the risk of injury and damage.

2.3.

If for any reason the Light Source is to be operated when not attached to a microscope, all personnel should wear eye shielding and clothing to protect the exposed skin.

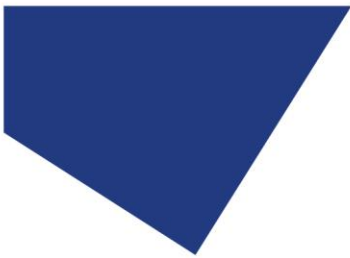

2.4.

Disconnecting the mains supply is achieved by unplugging the power cord from the power supply block or the Light Source. Only plug in the power cable, once the Light Source is attached to the microscope.

2.5.

There are no serviceable parts within the Light Source. Removing any of the screws and covers will result in the safety of the Light Source being impaired. The DC power supply unit should be inspected periodically throughout the lifetime of the system.

2.6.

Any electronic equipment connected to this product must comply with the requirements EN/IEC 60950.

2.7.

To clean the exterior of the Light Source, use a slightly dampened cloth with a simple water/detergent solution only. Avoid the optical surfaces and lenses. Cleaning of optics should only be carried out using optical wipes and fluids. Please note that the DC power supply unit should be isolated prior to cleaning.

RISK GROUP 3
WARNING UV emitted from this product. Avoid eye and skin exposure to unshielded product.
WARNING Possibly hazardous optical radiation emitted from this product. Do not look at operating lamp. Eye injury may result.
CAUTION IR emitted from this product. Avoid eye exposure. Use appropriate shielding or eye protection

All warnings may not be applicable depending on the version/wavelength being used.

2.8.

This product conforms to the requirements of the Safety Standards as follows:

EN/IEC 61010-1:2010	Safety requirements for Electrical Equipment for Measurement, Control and Laboratory use.
EN62471:2008	Photo-biological Safety of Lamps and Lamp Systems/ Guidance on manufacturing requirements relating to non-laser optical radiation safety. Risk Group 3.



2.9. EMC compliance

This product is tested to the requirements of standard IEC/EN 61326-1 concerning electromagnetic compatibility. This is a Class A product. In a domestic environment this product may cause radio interference in which case the user may be required to take adequate measures.



3. Getting Started – System Components

The CoolLED pE-800 Light Source is supplied with the following components:

- Main Light Source with Optical Output for 3 mm liquid light guide.
- DC Power Supply type GST160A12-R7B.
- IEC Power Cable.
- USB Cable.
- User Guide (USB stick).
- A variety of Hex keys.



In addition to the components listed above, it is possible that a liquid light guide, collimator or additional accessories will be supplied.



When un-packing the system, it is important to check the contents against the delivery note.

If any components are missing or appear damaged, please contact CoolLED or the reseller who supplied the equipment immediately.

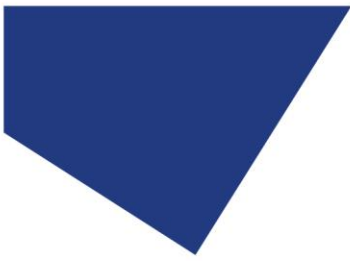

4. Installation and Setup

4.1.

Carefully unpack the components from the shipping material.

4.2.

Insert the power connector from the DC power supply as shown, with the flat of the connector body facing up. At this stage do not connect the mains power lead to the DC power supply.

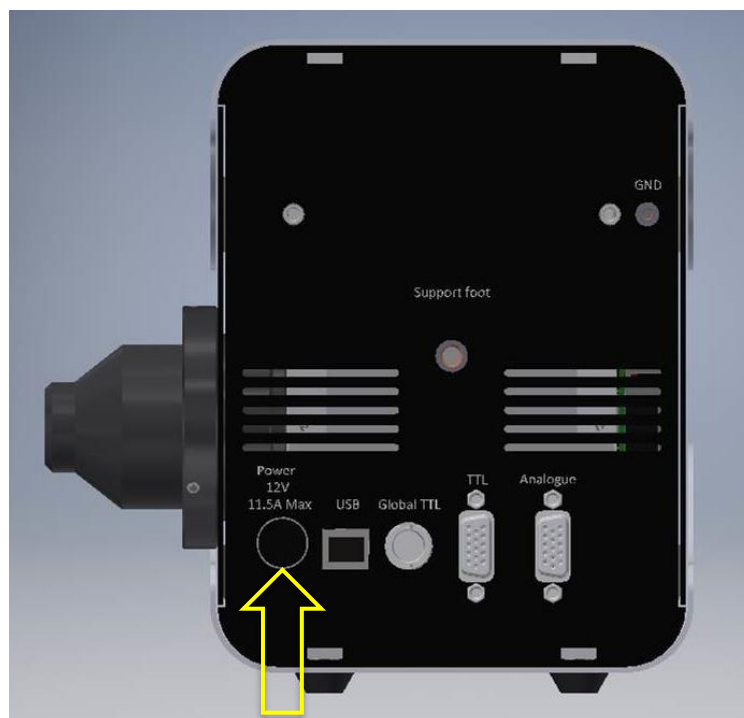



4.3.

Insert the liquid light guide into the light output port of the Light Source. Ensure that the end of the liquid light guide is fully inserted and gently tighten the grub screw to retain it in position.

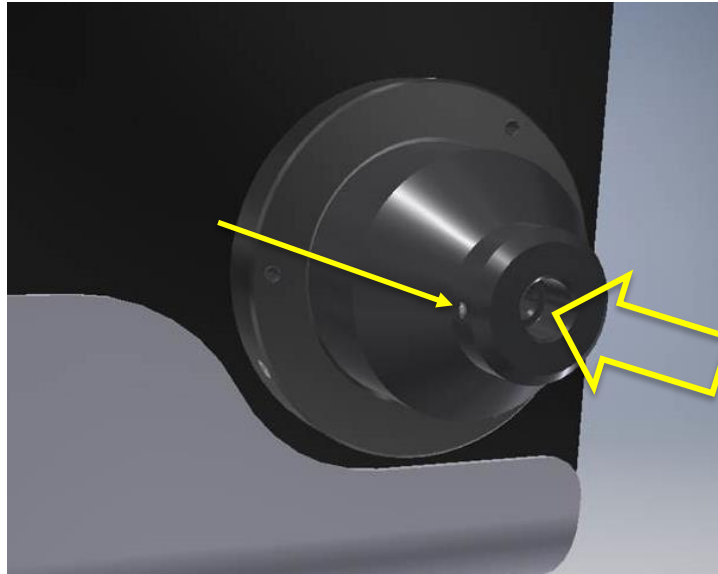

4.4.

Ensure that there is free airflow around the Light Source so that the cooling system is not impaired. A gap of 100 mm around the light source is sufficient. For optimal cooling performance the Light Source should only be operated in the orientation shown throughout this document, stood on its four rubber feet.

4.5.

Connect the second end of the liquid light guide into the desired microscope using the required coupling mechanism. If using the pE-Universal Collimator, refer to the dedicated User Manual for correct installation (www.cooled.com/products/accessories/pe-universal-collimator/).



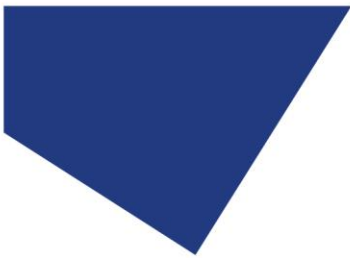

4.6.

With the liquid light guide fitted between the Light Source and the microscope, it is now safe to connect the mains power. Connect the mains lead supplied to a convenient socket, plug the IEC connector into the DC power supply and switch the power on at the mains. The pE-800 can now be switched on using the rocker switch shown in the below image.

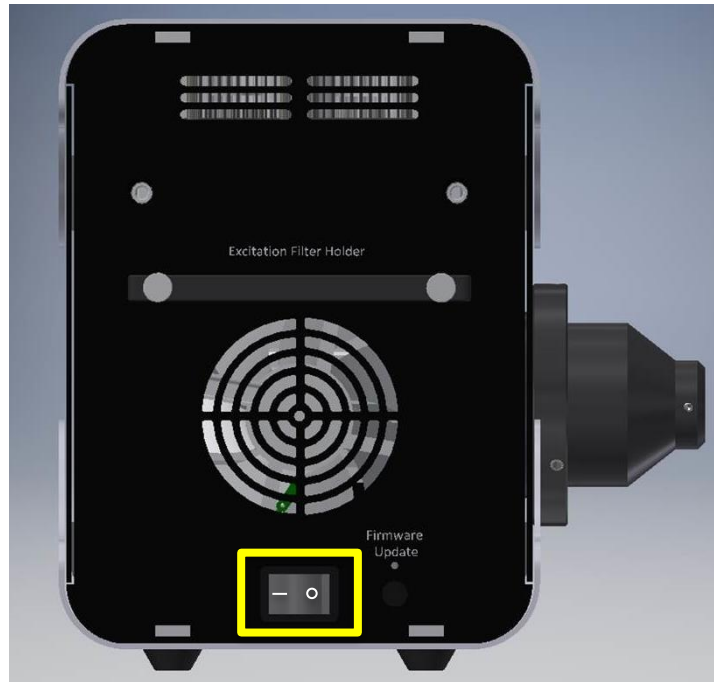

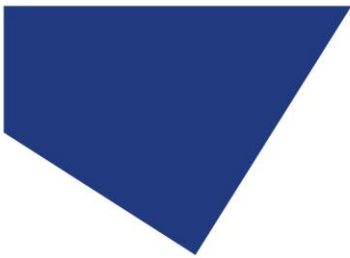

5. pE-800 LEDs overview

5.1.

The pE-800 is an eight-channel Illumination System, with each of the eight channels covering a distinct spectral region to suit use with common fluorophores and their relevant filter sets, from DAPI in the UV to Cy7 in the near infra-red. Each channel is individually controllable, allowing only the required LEDs to be illuminated and the irradiance of these to be adjusted to provide the desired signal.

5.2. Variants

In order to deliver the best performance with the wide range of available filter sets, it is necessary to have two variants of the pE-800. The “SB” variant which has an LED peaking at 365 nm in the UV region and the “MB” variant which has an LED peaking at 400 nm in the Violet region allow for optimal excitation of DAPI. All other installed LEDs remain the same across the two variants.

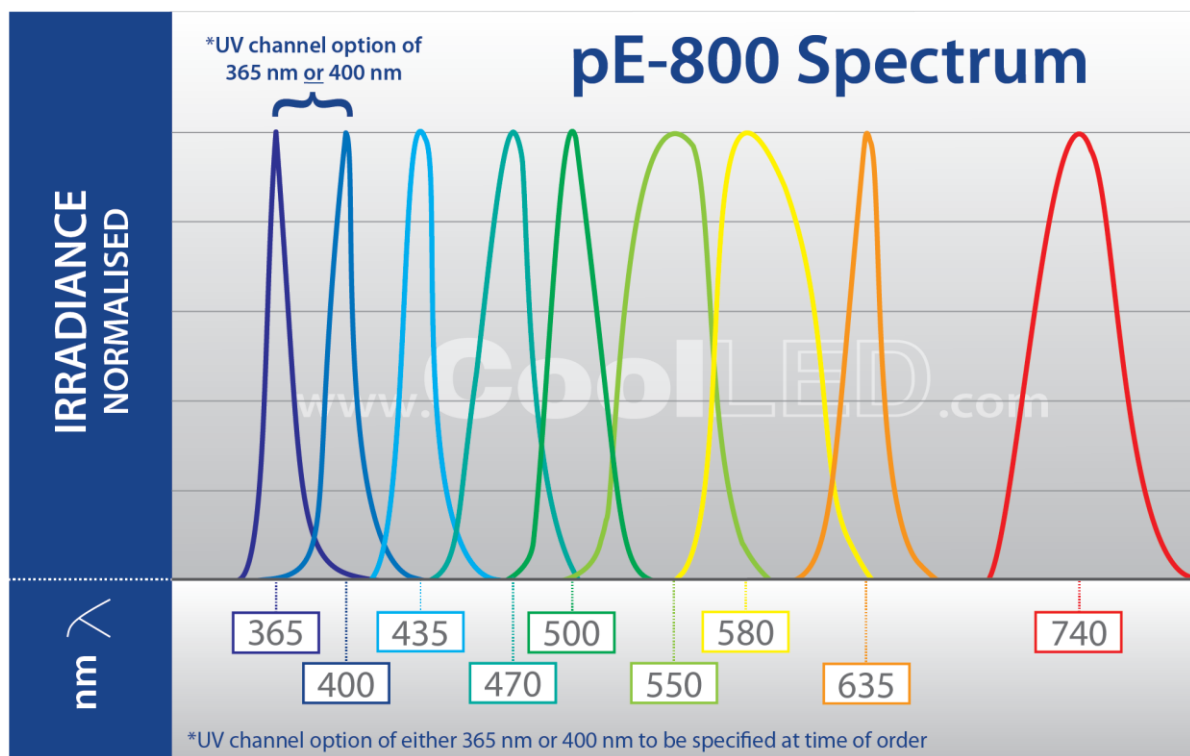



6. Control Overview

6.1. Communication requirements

To communicate with the pE-800 a connection needs to be made between the PC and Light Source. A USB A-male to B-male cable will have been provided with the System. Connect the USB A connector into a free port on the PC and connect the USB B connector into the USB socket on the Light Source side panel (next to the power input). Please note the correct orientation of this connector, with the top-side of the cable housing facing up.

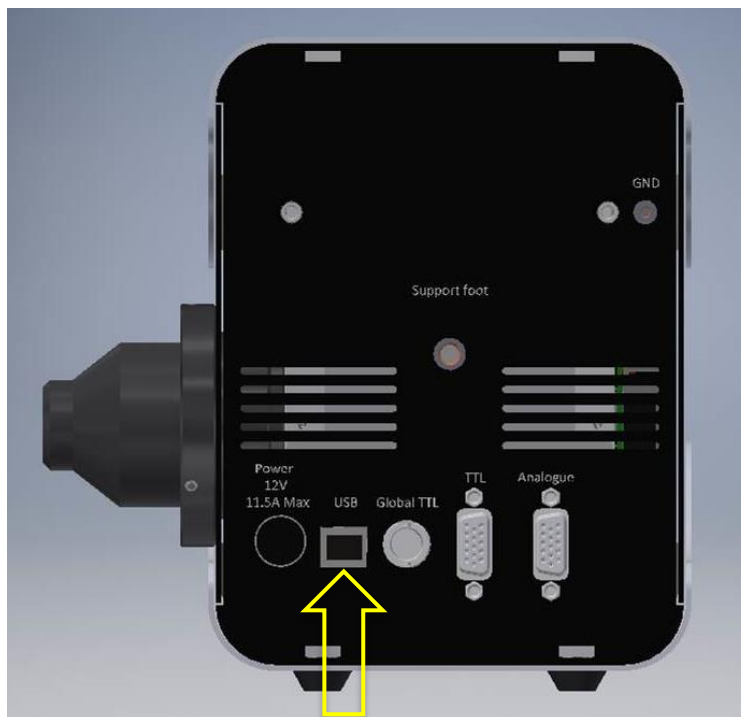

The interface is a 'virtual COM port' style and a setup procedure may be necessary to enable communication between a PC and the Light Source. See [Appendix 1](#) for more details.

6.2. CoolLED LightBridge

To allow control of the pE-800, CoolLED has developed a graphical user interface called the LightBridge.

The LightBridge software can be downloaded either from the User Guide (USB stick) that is provided with the pE-800 or from the CoolLED website (www.cooled.com/support/imaging-software/).

Details of the operation of the LightBridge can be found in the relevant section of this User Manual.

Communication with the LightBridge is achieved through a USB connection.

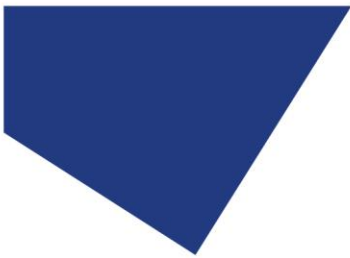

6.3. Third party Imaging Software

The pE-800 can be operated under a range of popular imaging software packages. Details of specific packages can be found on the CoolLED website (www.coolled.com/support/imaging-software/).

6.4. TTL

The pE-800 can be controlled directly by TTL signals to control the ON/OFF state of the Light Source. To define the LED irradiance or to set a sequence, the TTL signals will need to be applied in combination with communication from the LightBridge application.

Details of the voltage requirements and the switching performance are shown in the graph below.

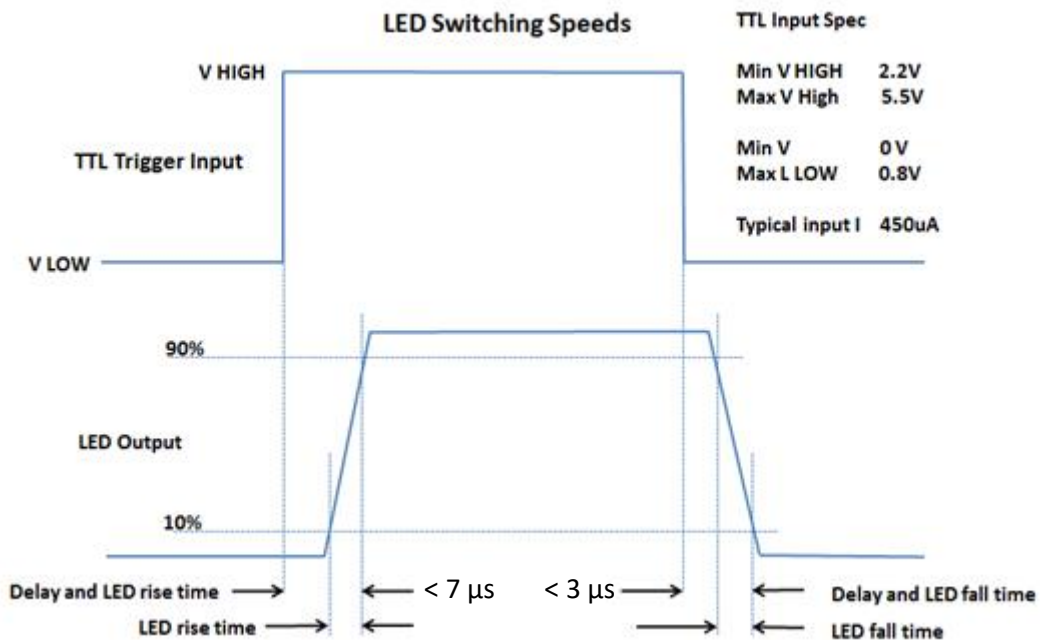



The details of the physical TTL connections for the pE-800 are shown below.

TTL Port 15 Position D-Sub, High Density Receptacle, Female Sockets Connector			
Pin #	Name	Type	Maximum Rate Input/Output Voltages
1	635 nm	Digital Input	$0 \leq V_{in} \leq 5.5 \text{ V}$
2	550 nm	Digital Input	$0 \leq V_{in} \leq 5.5 \text{ V}$
3	470 nm	Digital Input	$0 \leq V_{in} \leq 5.5 \text{ V}$
4	TTL OUT 2	Digital Output	$0 \leq V_{out} \leq 3.3 \text{ V (typ)}$ $0.4 \text{ (max)} \leq V_{out} \leq 2.9 \text{ V(min)}$
5	GLOBAL TTL	Digital Input	$0 \leq V_{in} \leq 5.5 \text{ V}$
6	GROUND	Power	-
7	GROUND	Power	-
8	GROUND	Power	-
9	TTL OUT 1	Digital Output	$0 \leq V_{out} \leq 3.3 \text{ V (typ)}$ $0.4 \text{ (max)} \leq V_{out} \leq 2.9 \text{ V(min)}$
10	GROUND	Power	-
11	500 nm	Digital Input	$0 \leq V_{in} \leq 5.5 \text{ V}$
12	435 nm	Digital Input	$0 \leq V_{in} \leq 5.5 \text{ V}$
13	365 nm	Digital Input	$0 \leq V_{in} \leq 5.5 \text{ V}$
14	740 nm	Digital Input	$0 \leq V_{in} \leq 5.5 \text{ V}$
15	580 nm	Digital Input	$0 \leq V_{in} \leq 5.5 \text{ V}$
Global Input BNC Connector Jack, Female Socket 50Ω			
Pin #	Name	Type	Maximum Rate Input/Output Voltages
1	GLOBAL TTL	Digital Input	$0 \leq V_{in} \leq 5.5 \text{ V}$

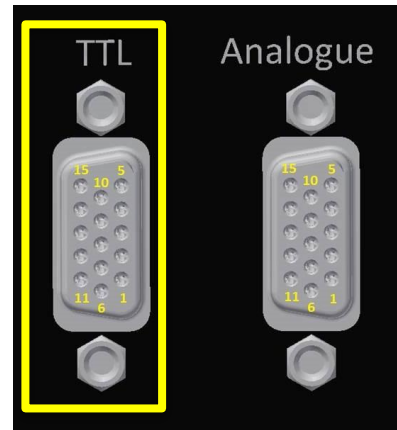
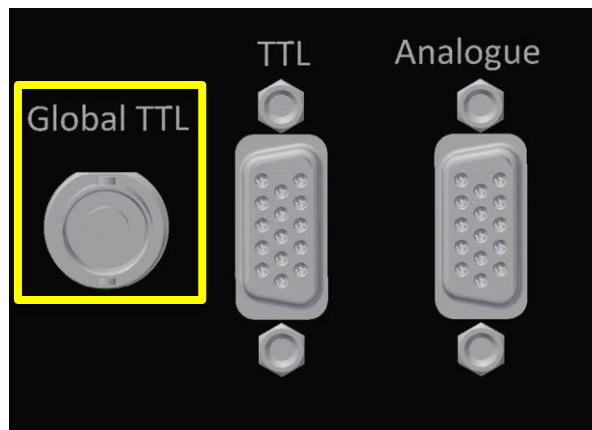



6.5. Analogue

The irradiance of the LEDs in the pE-800 can be set by applying an Analogue Voltage to the relevant connections. A signal of 0-10 V can be applied to the Analogue inputs and relates to 0-100 % irradiance. For example, a 6.5 V signal applied to an input will set the channel to 65 % irradiance.

The details of the physical Analogue connections for the pE-800 are shown below.

Analogue Port			
15 Position D-Sub, High Density Receptacle, Female Sockets Connector			
Pin #	Name	Type	Maximum Rate Input/Output Voltages
1	635 nm	Analogue Input	$0 \leq V_{in} \leq 10 \text{ V}$
2	550 nm	Analogue Input	$0 \leq V_{in} \leq 5.5 \text{ V}$
3	470 nm	Analogue Input	$0 \leq V_{in} \leq 5.5 \text{ V}$
4	ANALOGUE OUT 2	Analogue Output	$0 \leq V_{out} \leq 10 \text{ V}$
5	INTERLOCK	Digital Input	$0 \leq V_{in} \leq 5.5 \text{ V}$
6	ANALOGUE GROUND	Power	-
7	ANALOGUE GROUND	Power	-
8	ANALOGUE GROUND	Power	-
9	ANALOGUE OUT 1	Analogue Output	$0 \leq V_{out} \leq 10 \text{ V}$
10	GROUND	Power	-
11	500 nm	Digital Input	$0 \leq V_{in} \leq 5.5 \text{ V}$
12	435 nm	Digital Input	$0 \leq V_{in} \leq 5.5 \text{ V}$
13	365 nm	Digital Input	$0 \leq V_{in} \leq 5.5 \text{ V}$
14	740 nm	Digital Input	$0 \leq V_{in} \leq 5.5 \text{ V}$
15	580 nm	Digital Input	$0 \leq V_{in} \leq 5.5 \text{ V}$

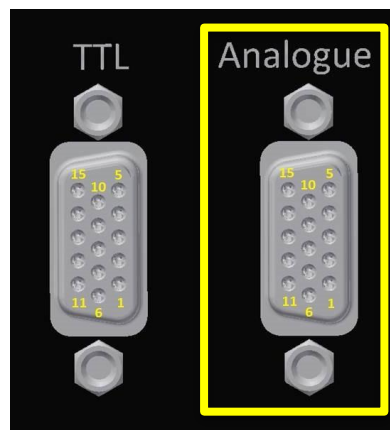

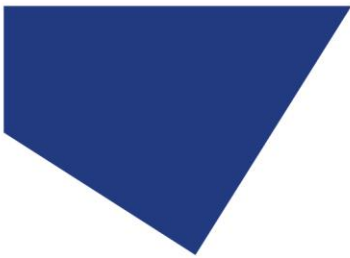

7. LightBridge – Standard/TTL mode

7.1.

When the CoolLED LightBridge is opened the below display will be shown (if the pE-800 is not switched on). The status will be shown in the bottom right corner as Offline.



7.2.

Once the power switch of the Light Source is turned on and the System is connected to the PC with a USB cable, the LightBridge will detect the presence of the Light Source and show the status as “Online”. At this point the installed LEDs listed at the top of the display will be updated to reflect whether an SB or MB version of the pE-800 is being used.

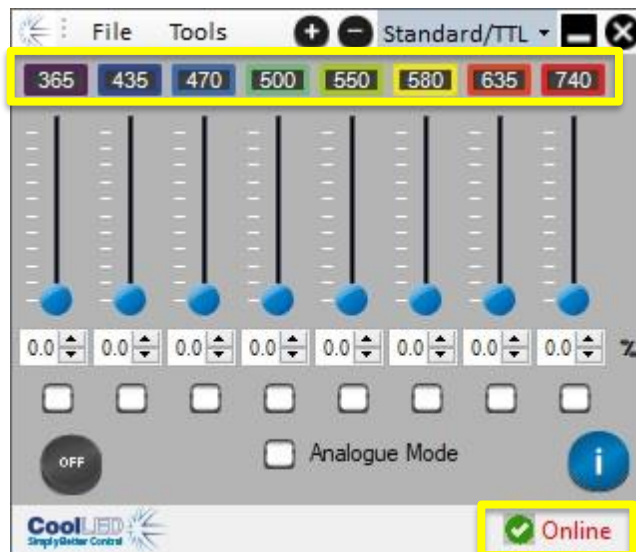



7.3.

The irradiance of each of the eight channels can be adjusted by either clicking and moving the slider with your mouse, typing the irradiance figure in the text box or adjusting the irradiance using the arrows.

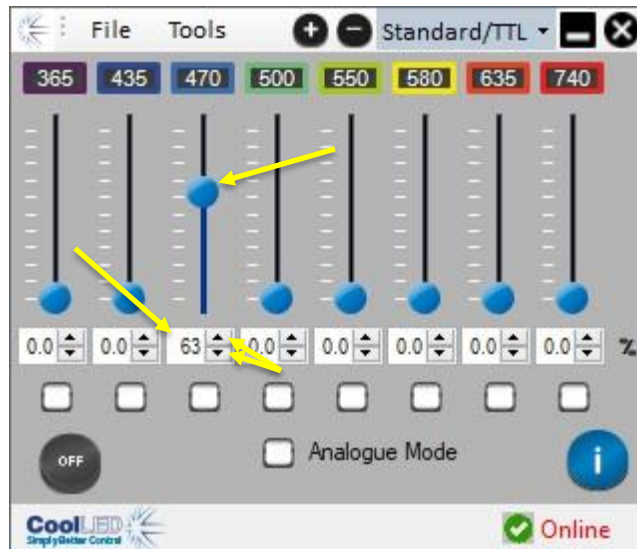

7.4.

Checking the box below the irradiance figure will put that channel into a selected state.

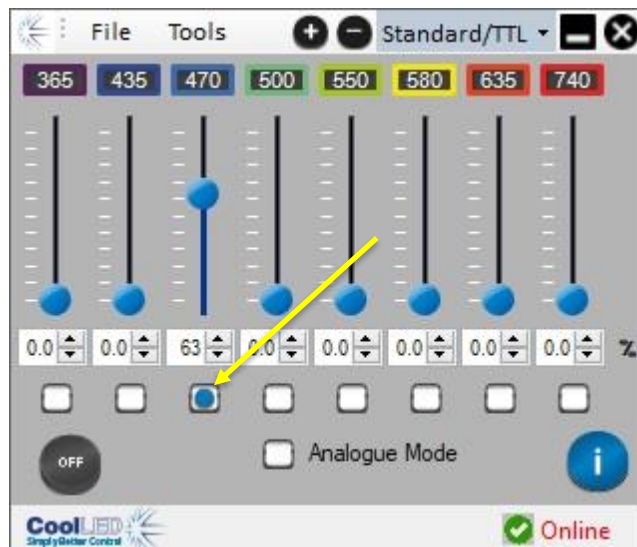

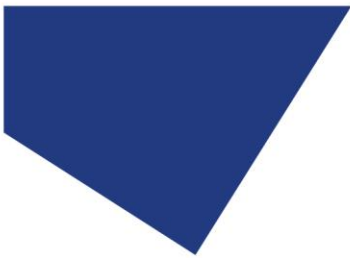

7.5.

Pressing the On/Off button in the bottom left corner of the display will cause all wavelengths in the selected state to illuminate at their defined irradiance.

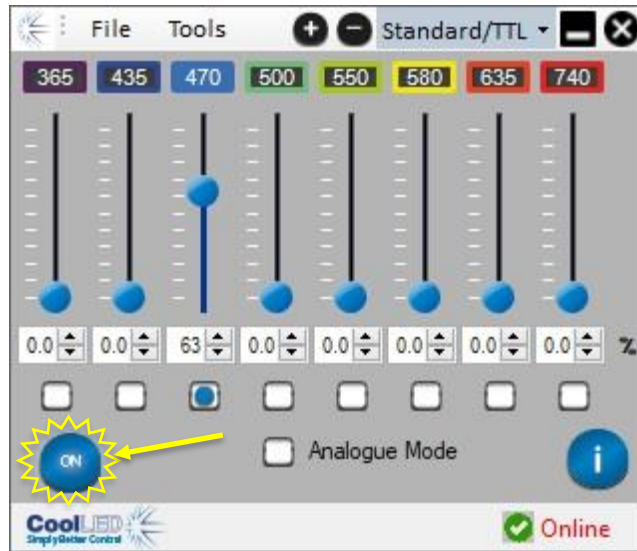

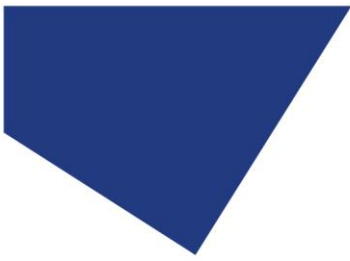

8. LightBridge – Analogue Mode

Checking the Analogue mode box removes the ability to control the On/Off status and the channel irradiance through the LightBridge. The pE-800 irradiance level will now be controllable from a voltage between 0-10 V to the relevant Analogue input pin. The On/Off state of the Light Source will be controllable with a TTL signal. This could either be to the global TTL pin (all channels with an Analogue signal applied will illuminate with a TTL high). It could instead be to the dedicated channel TTL inputs (the dedicated channel will illuminate if an Analogue signal is applied to the corresponding channel that also has a TTL high applied).

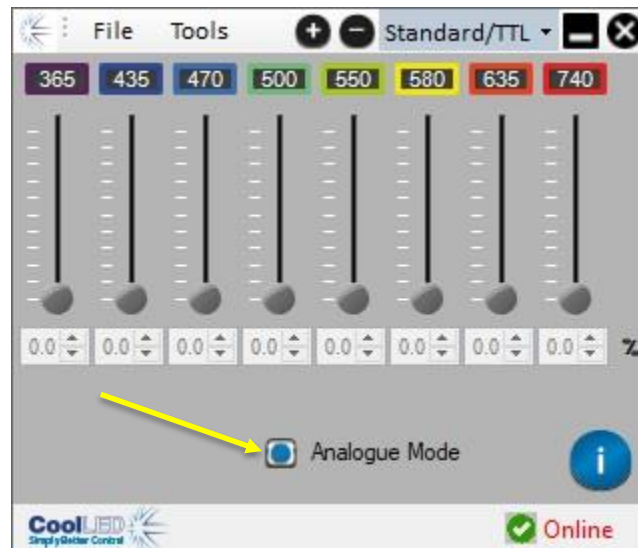



9. LightBridge – Sequence Runner Mode

9.1.

To access Sequence Runner Mode click on the dropdown tab at the top of the page that is labelled “Standard/TTL” under normal operating conditions. Select “Sequence” from the dropdown list.

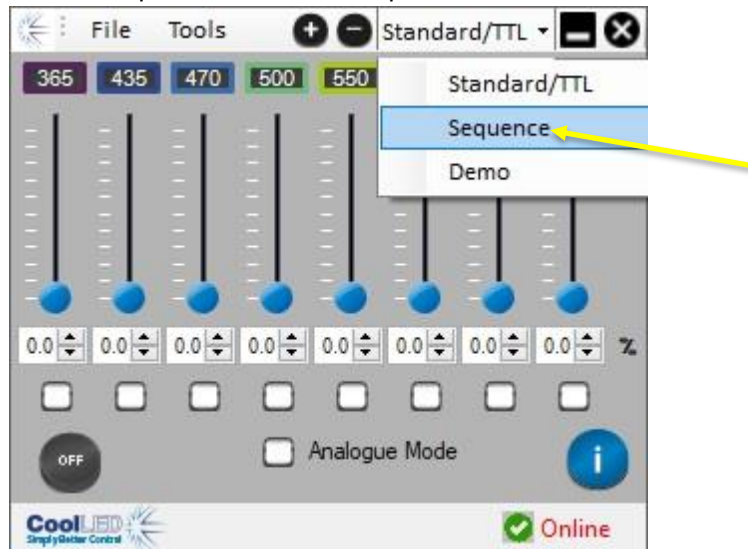

9.2.

Once “Sequence Runner Mode” is selected the following display will be shown. All channels will be set to the off state at 0 % irradiance.

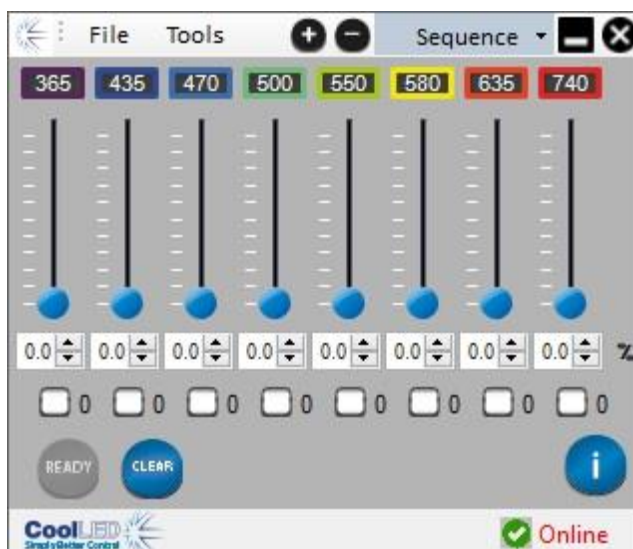

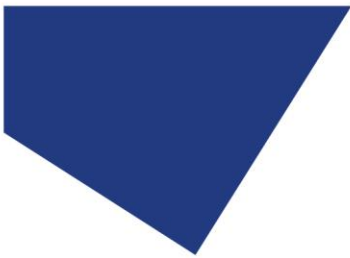

9.3.

Define the triggering order by checking the boxes of the required channels in the order you would like them to illuminate. The first box checked will select the first channel of a triggering sequence, the second box will select the second channel and so on. This will be shown by a number appearing next to the check box to show this order. The irradiance will also need to be set using either the slider, arrows or text boxes for each required channel.

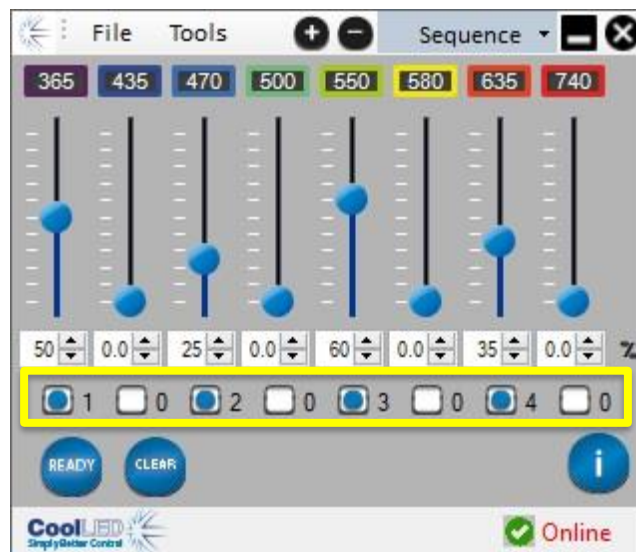

9.4.

To activate the sequence, click the "Ready" button.

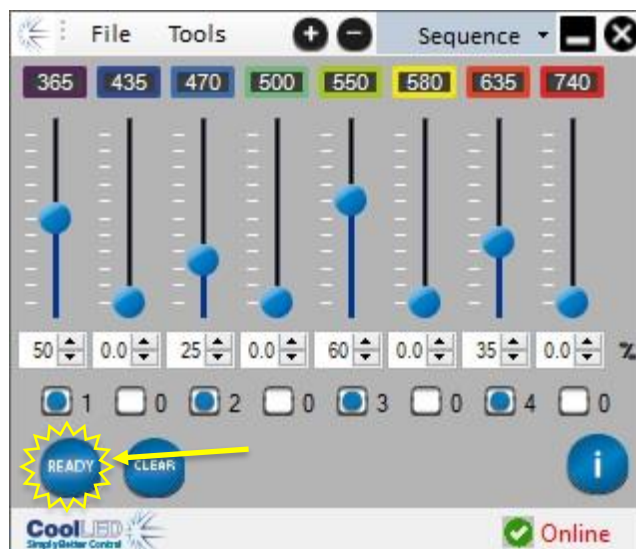



9.5.

“Sequence is running” will be displayed to show that the sequence is active.

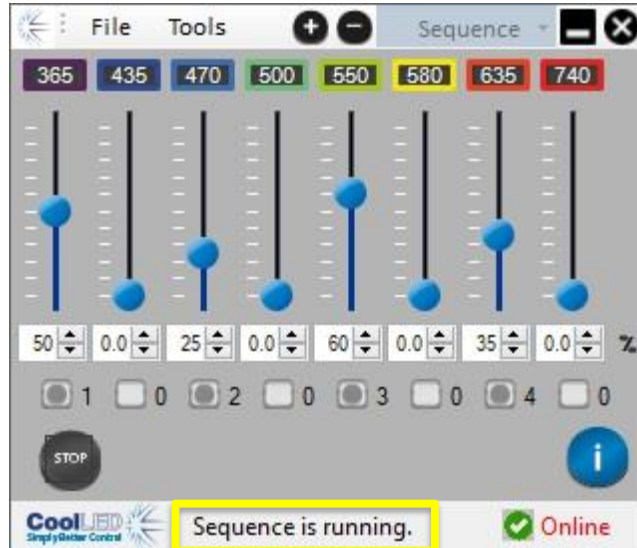

The pE-800 will now trigger the defined channels in the order selected with every TTL high signal to the “Global TTL” input.

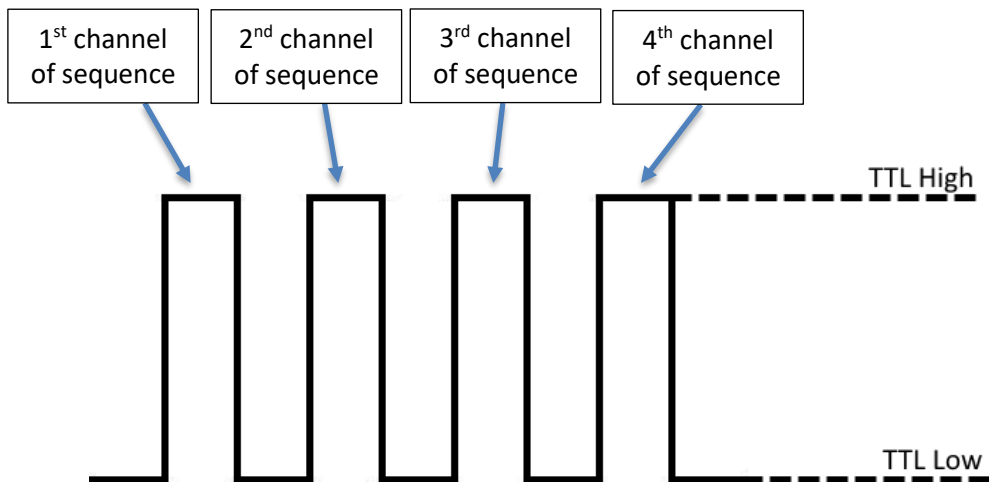

The order of triggering is now fixed until the sequence is stopped, but the irradiance level of channels can still be adjusted.



9.6.

To stop the sequence, click the “Stop” button.

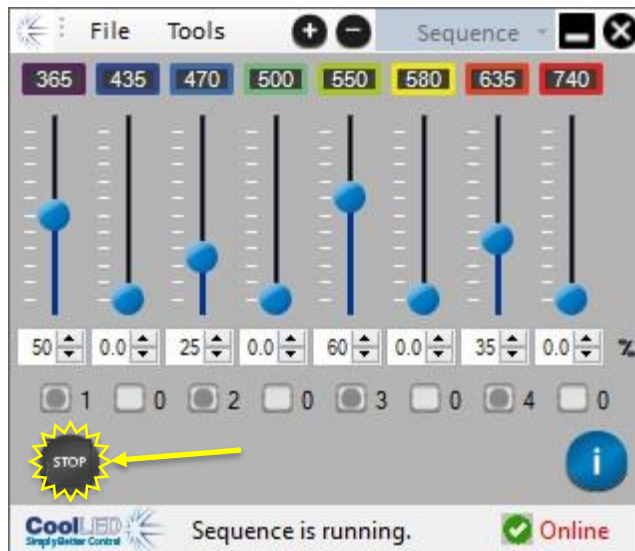

9.7.

If you wish to change the defined triggering order, press the “Clear” button.

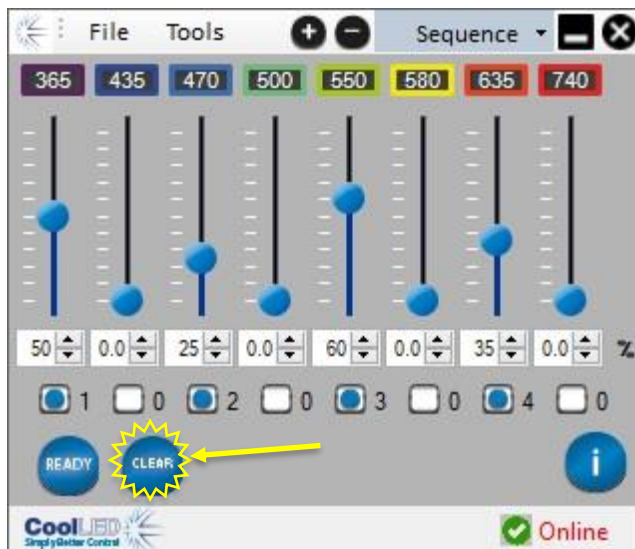

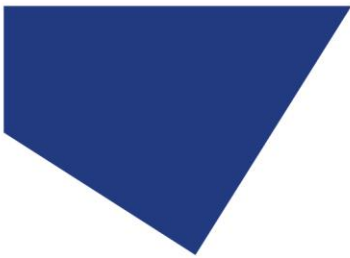

9.8.

All the checkboxes will now be reset and list "0" next to all channels.

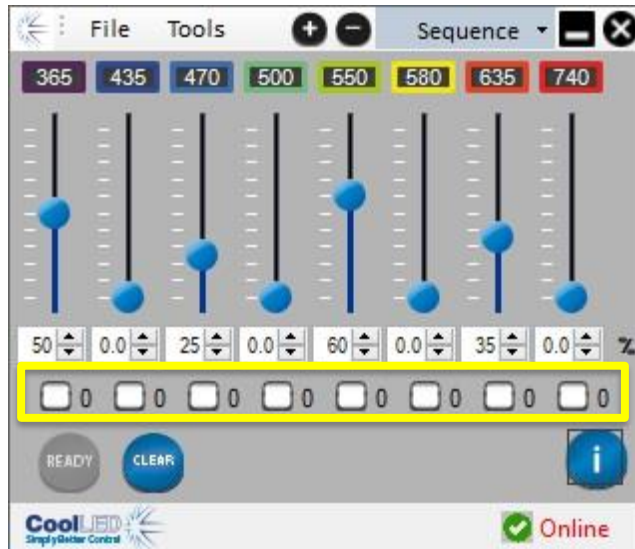

10. LightBridge – Demo Mode

10.1.

The CoolLED LightBridge includes a Demo mode, which allows some of the features and a level of automation to be demonstrated without the need for additional hardware or software.

10.2.

To access "Demo Mode" click on the dropdown tab at the top of the page that is labelled "Standard/TTL" under normal operating conditions. Select "Demo" from the dropdown list.

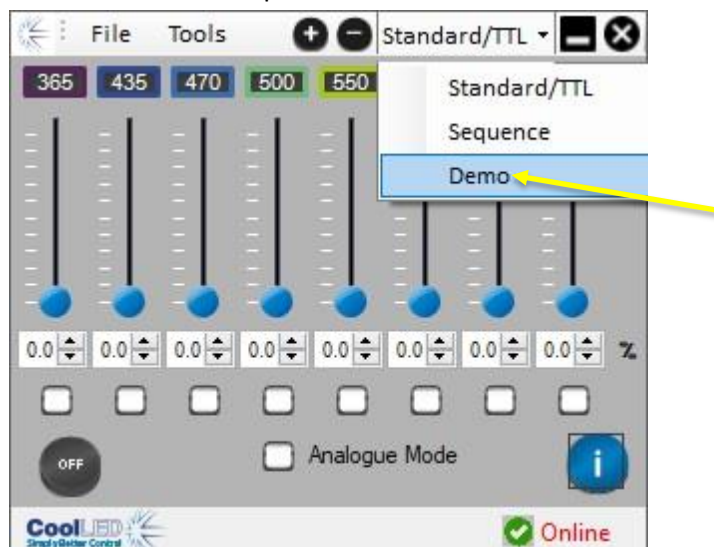



10.3.

Once “Demo Mode” is selected the following display will be shown. All channels will be set to the off state at 0 % irradiance.



10.4.

Set the required channel irradiance levels by adjusting the relevant slider, typing in the text box or using the arrows. Define the selected channels by clicking in the designated check box. The order in which these are selected will be the order in which they illuminate. This will be indicated by a number appearing next to the box.

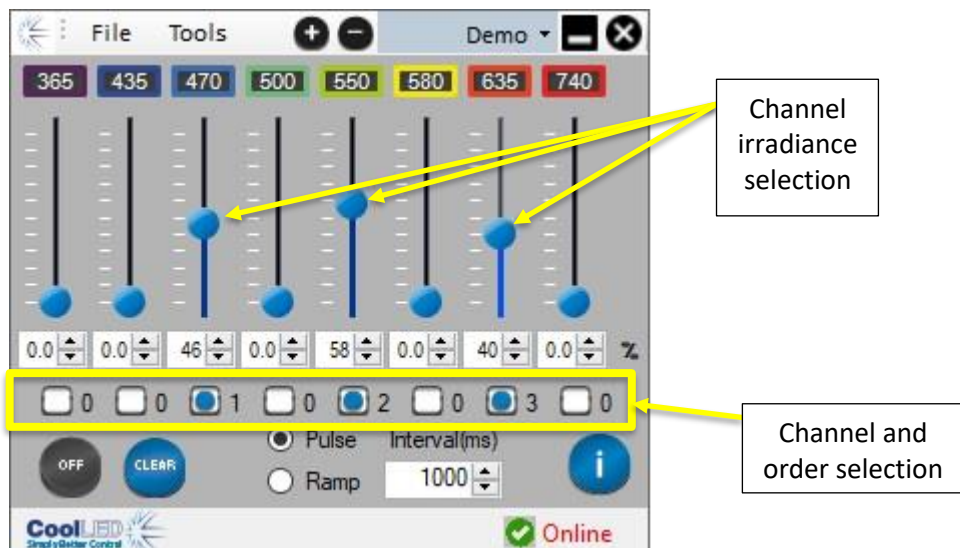

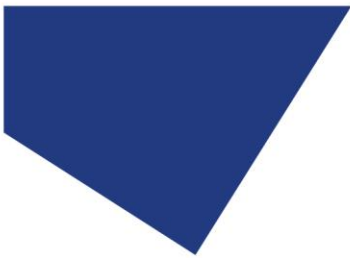

10.5.

Select whether you would like the light output to be a pulse or to ramp up by checking the box for one of these fields.

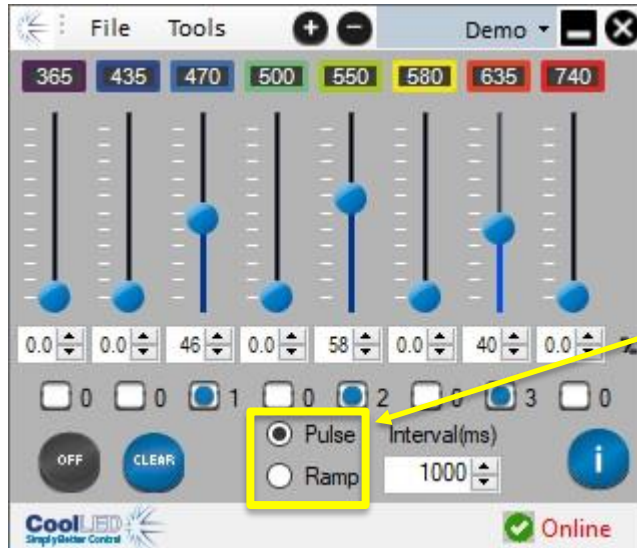

10.6.

Define the pulsing interval or ramp duration by typing in the text box or using the arrows.

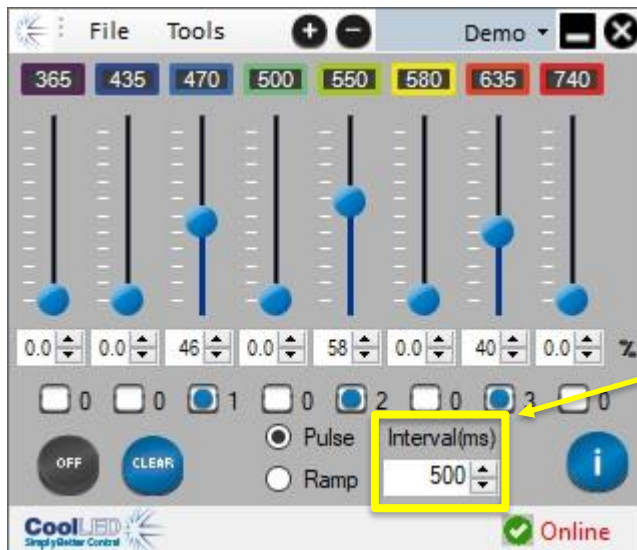

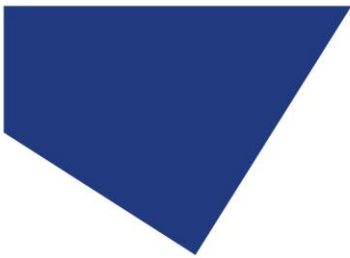

10.7.

To start the demonstration sequence, press the “OFF” button to change the state to “ON”.

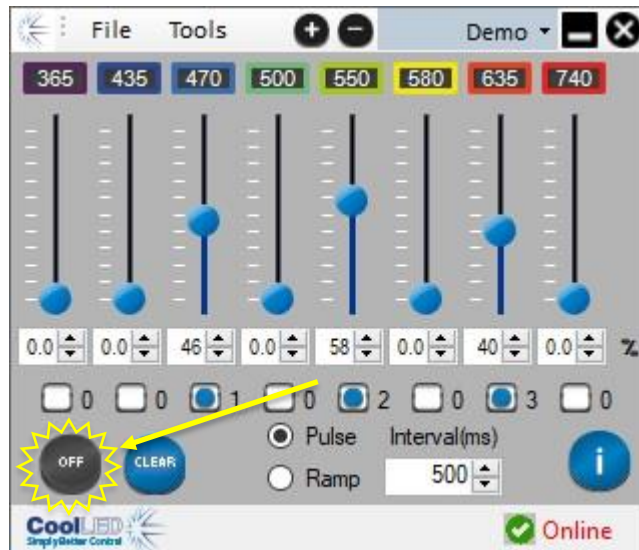

10.8.

Whilst the sequence is running the selected channels, order of triggering and interval cannot be adjusted.

To stop the sequence, press the “ON” button to change the state to “OFF”.

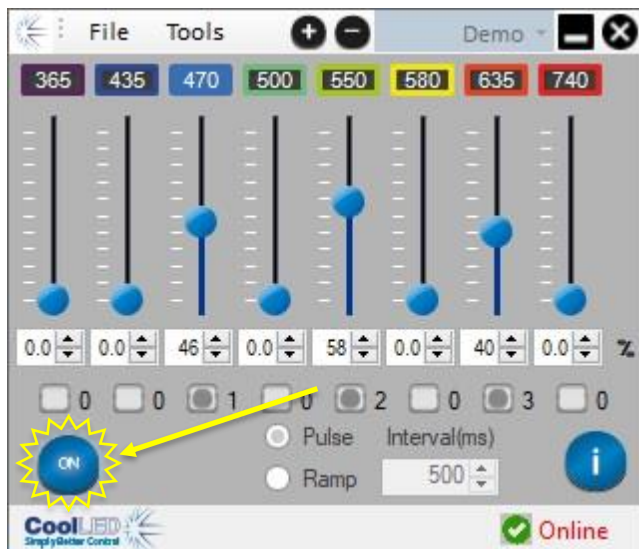



10.9.

To change the channels that will be triggered or adjust the order, the clear button will need to be pressed.

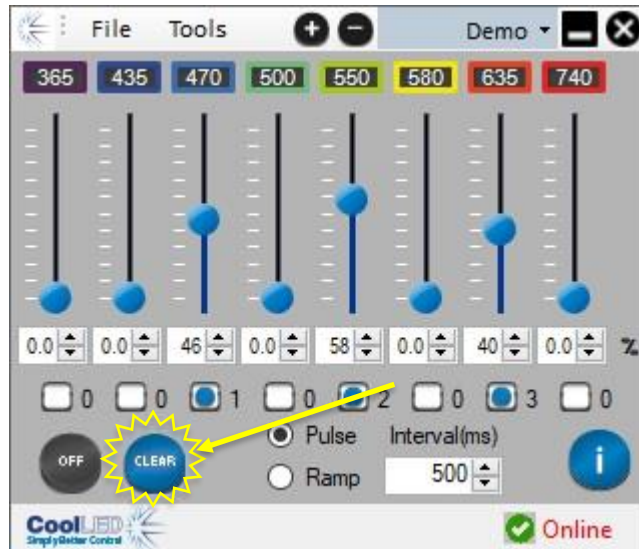

10.10.

All channels will have their sequence order returned to "0". The other settings will remain.

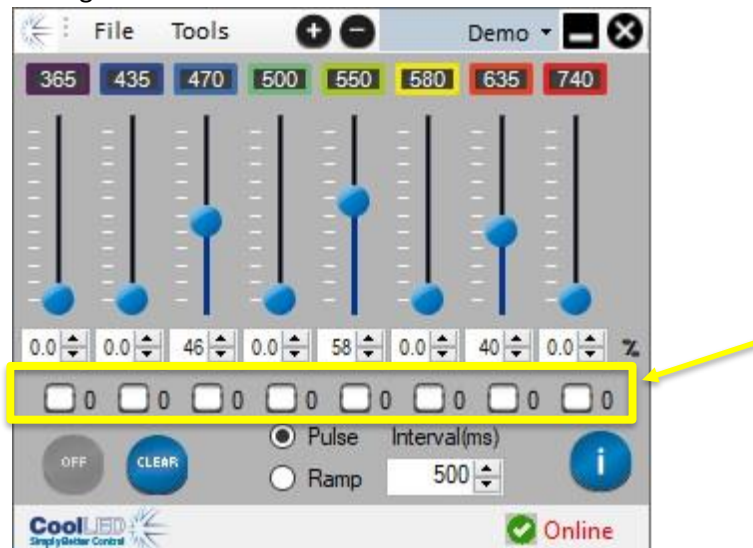

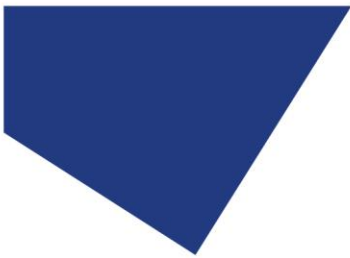

11. LightBridge – Additional settings

11.1. Power Up Configurator

The Power Up Configurator allows you to determine the mode of operation, channel intensities and selected state that the pE-800 will default to when powered up connected to the LightBridge.

11.1.1.

The Power Up Configurator can be accessed from the “Tools” drop-down menu at the top of the page.

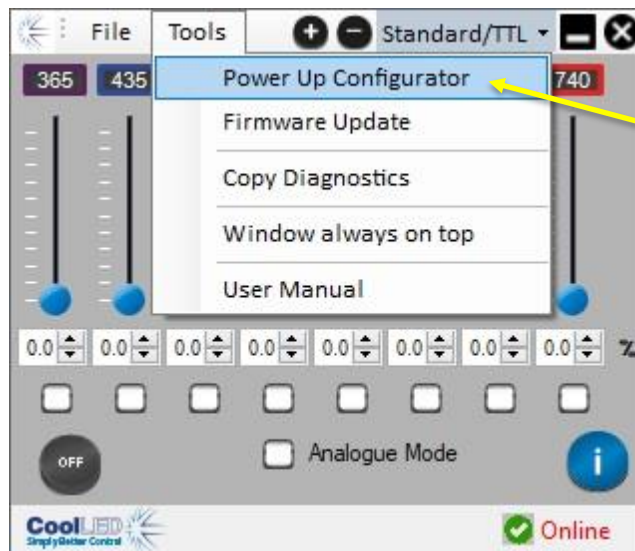

11.1.2.

The below window will be displayed showing the available channels and information.

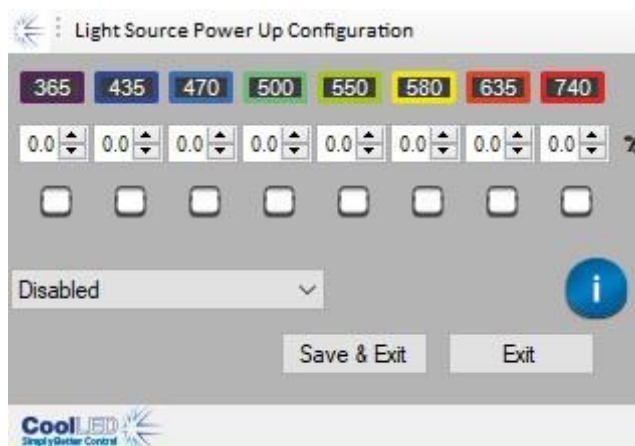



11.1.3.

The channel irradiance levels can be adjusted by either typing into the text box or using the arrow buttons. The selected state of each of the channels can also be set using the relevant check boxes.

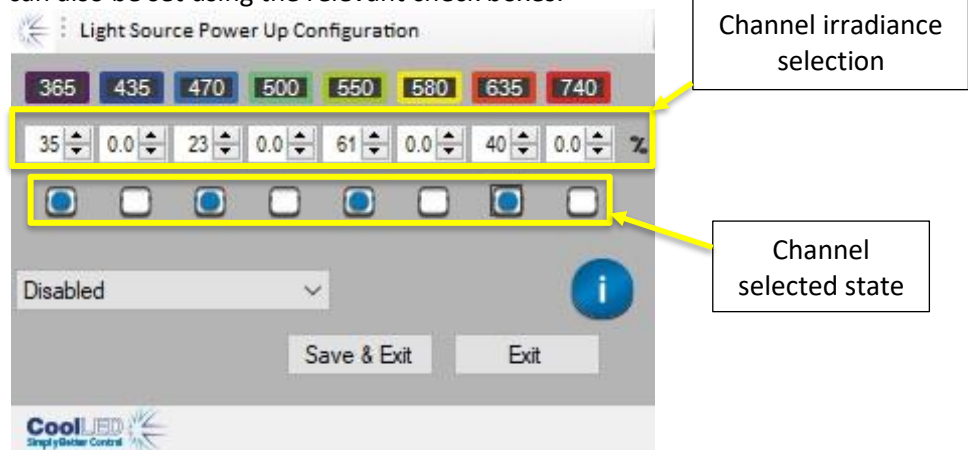

11.1.4.

Alternatively, the pE-800 can be set to initialise in “Analogue Mode” by selecting the “Analogue enable” option from the dropdown menu. The channel selection and irradiance levels will be unavailable, as these will be defined by the Analogue signals applied to the pE-800.

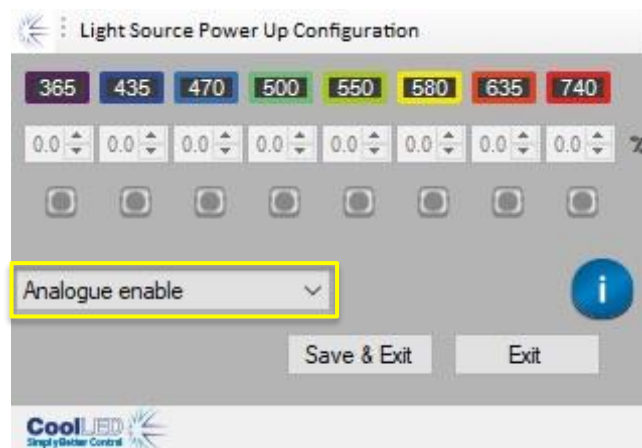



11.1.5.

For the chosen settings to be selected upon power-up, the “Irradiance level set, LEDs on” or “Irradiance level set, LEDs off” option needs to be selected from the dropdown menu.

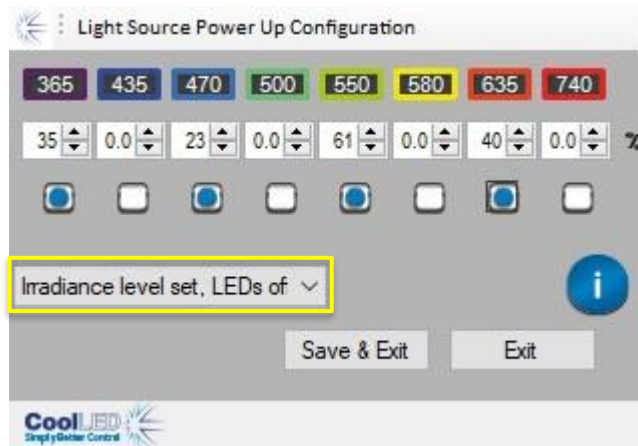

11.1.6.

To confirm the settings, press the “Save & Exit” button. Alternatively, if you do not wish to confirm the settings press the “Exit” button. Both options will return you to the mode that you were in before entering the Power Up Configurator.

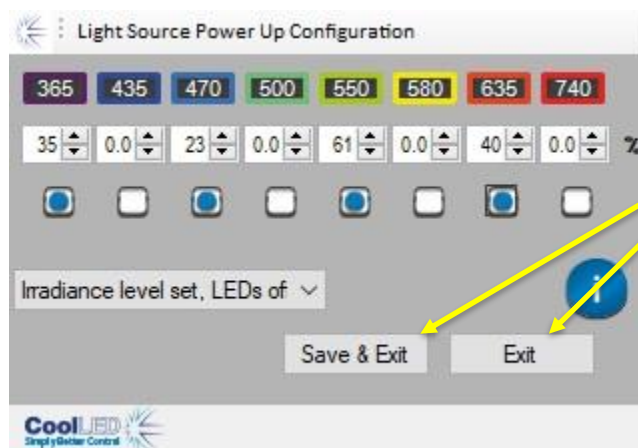

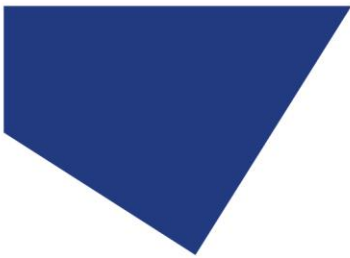

11.2. System information

Information about the pE-800 can be accessed using the LightBridge.

11.2.1.

To access the system information, please select the 'About' option from the 'File' dropdown menu.

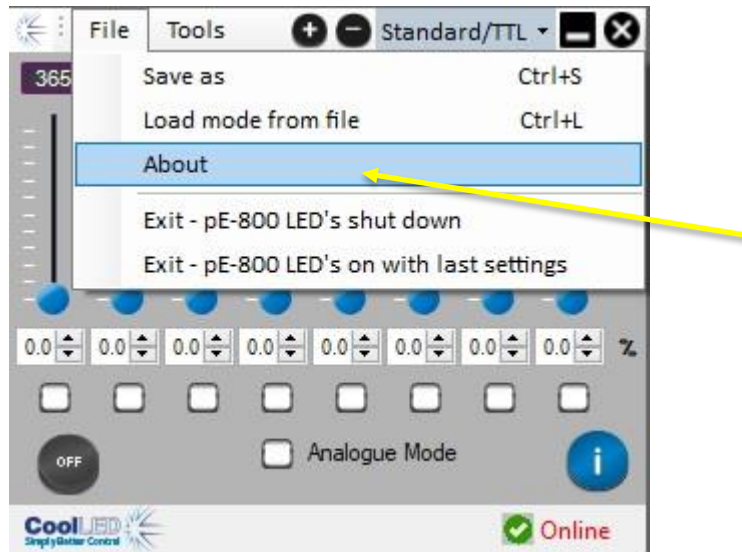

11.2.2.

The following window will be displayed.

The 'Software version' refers to the version of LightBridge that is being operated.

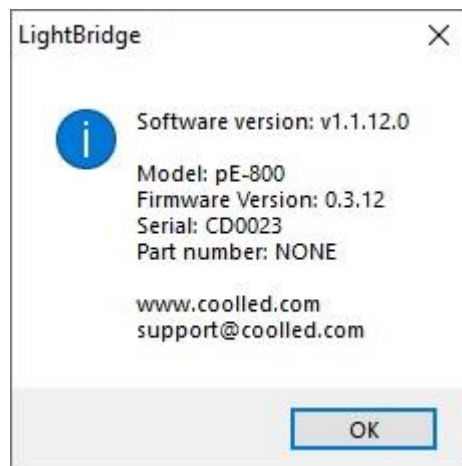



11.3. LightBridge display settings

11.3.1.

The LightBridge application window can be increased or decreased in size by using the '+' or '-' buttons at the top of the window.



11.3.2.

To ensure that the Lightbridge application is always accessible when using multiple applications, it is possible to set the LightBridge to always appear in front of other windows.

To access this setting select the 'Window always on top' option from the 'Tools' dropdown menu.

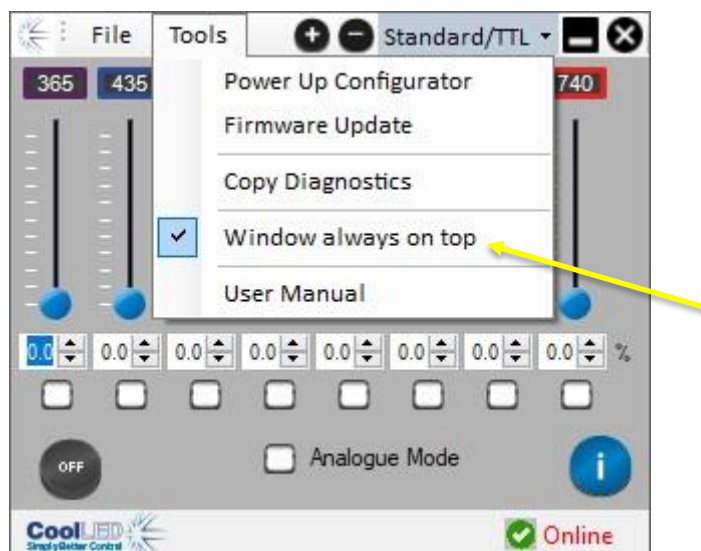

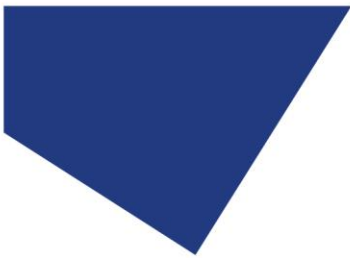

11.4. Saving and loading settings

11.4.1.

It is possible to save the current settings in the LightBridge to be recalled later. With the desired settings in place, select the “Save as” option from the “File” dropdown menu.

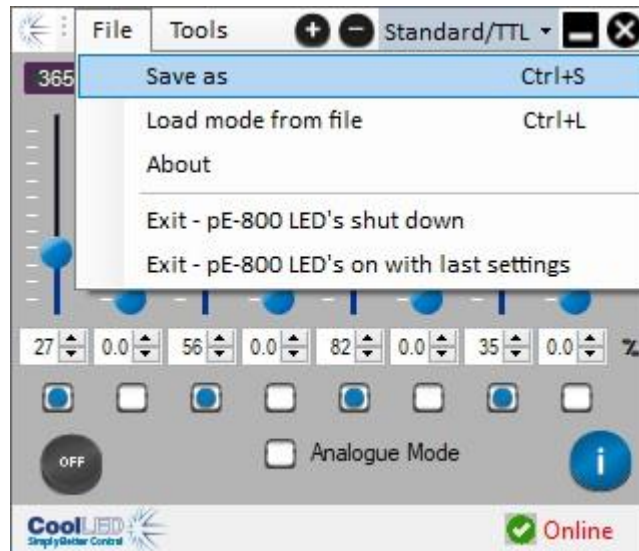

11.4.2.

A window similar to the below example shall be displayed. Choose the location to save, name the file and press the “Save” button.

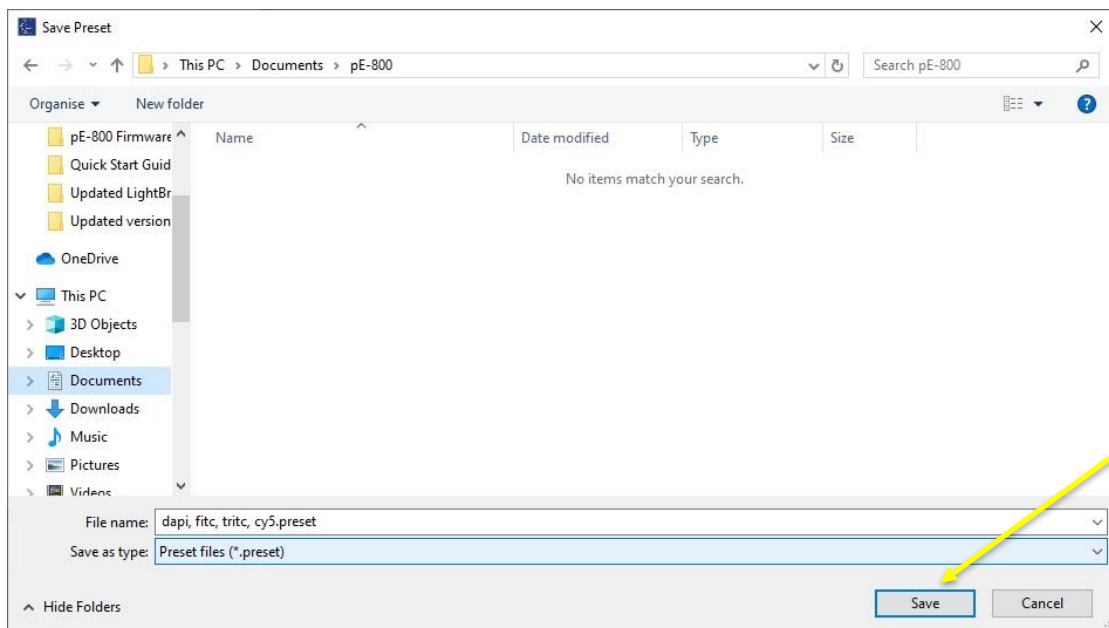

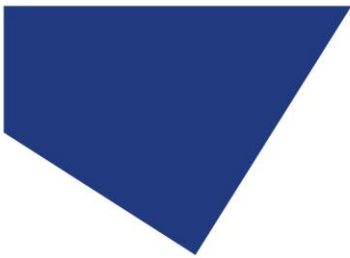

11.4.3.

The saved settings will be confirmed at the bottom of the LightBridge window.

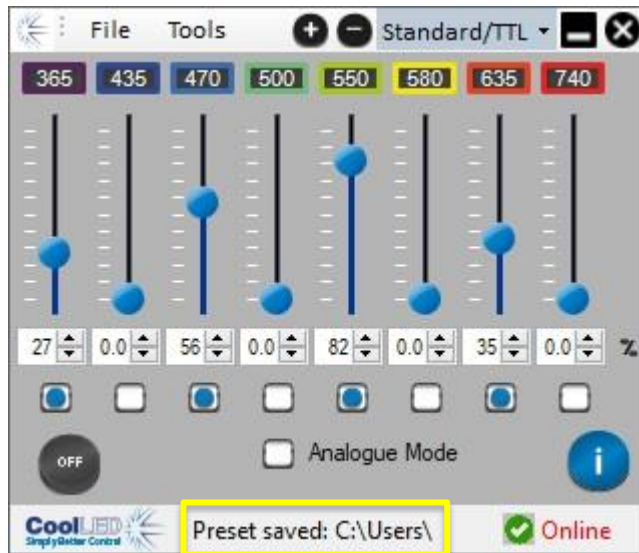

11.4.4.

To load previously saved settings, select the “Load mode from file” option from the “File” dropdown menu.

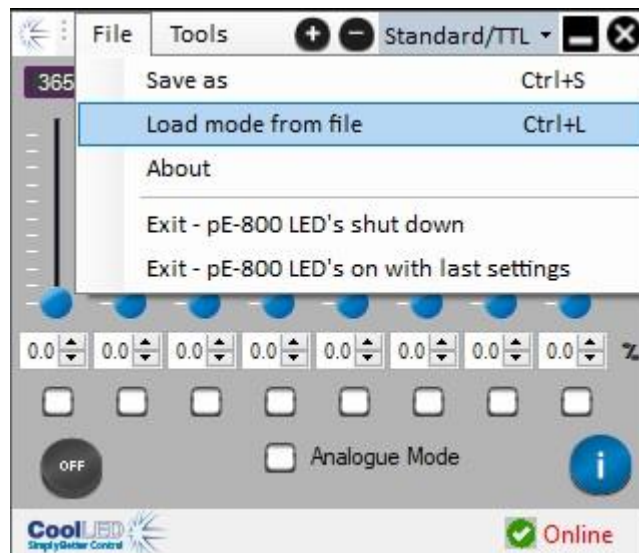



11.4.5.

Select the desired preset file from your saved location and press the “Open” button.

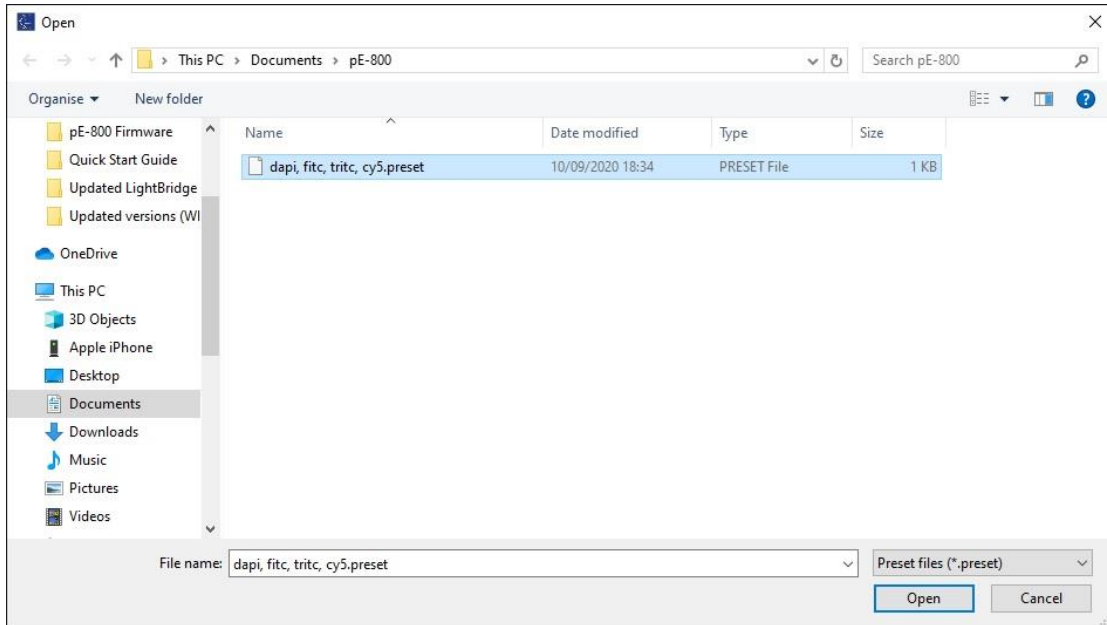

11.4.6.

The loaded settings will be shown on the LightBridge window.

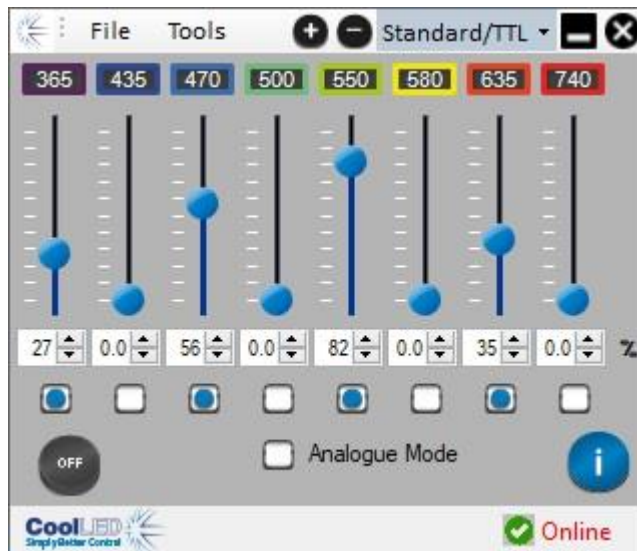

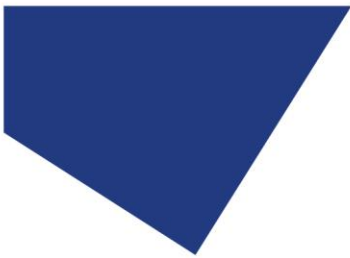

11.5. Exiting the LightBridge

When pressing the “X” button in the top-right hand corner of the LightBridge to exit the application, you will be presented with a dropdown menu.

Pressing the “Exit – pE-800 LED’s shut down” option will close the LightBridge and change the state of the Light Source to OFF.

Pressing the “Exit – pE-800 LED’s on with last settings” option will close the LightBridge but maintain the current state of all channels. This may be required if continuing to control the Light Source externally (for example via TTL).

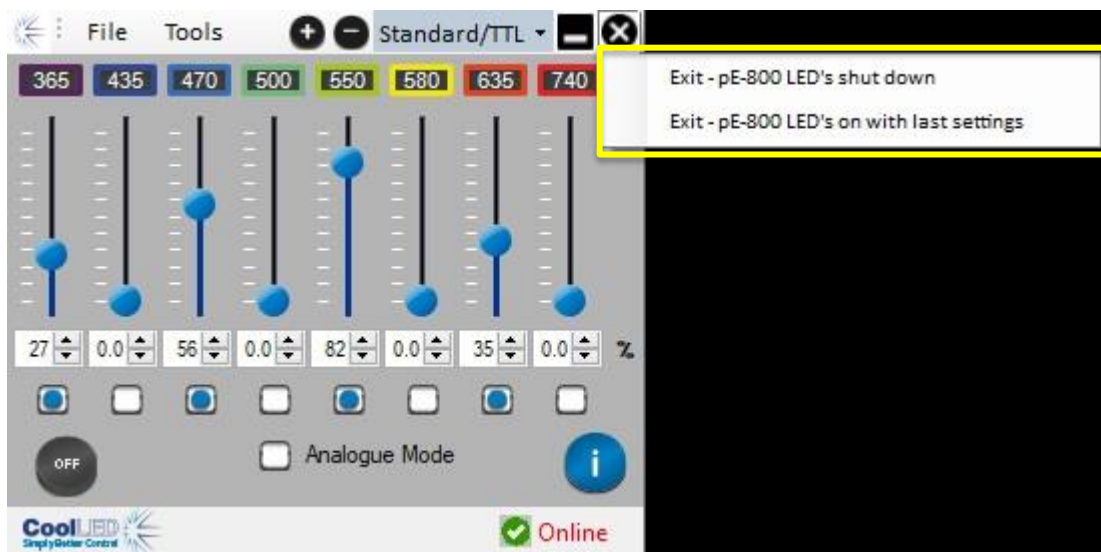



12. Fitting Excitation Filters

12.1.

An Excitation Filter Holder is provided with all pE-800 Systems as standard. This will arrive installed into the Light Source.

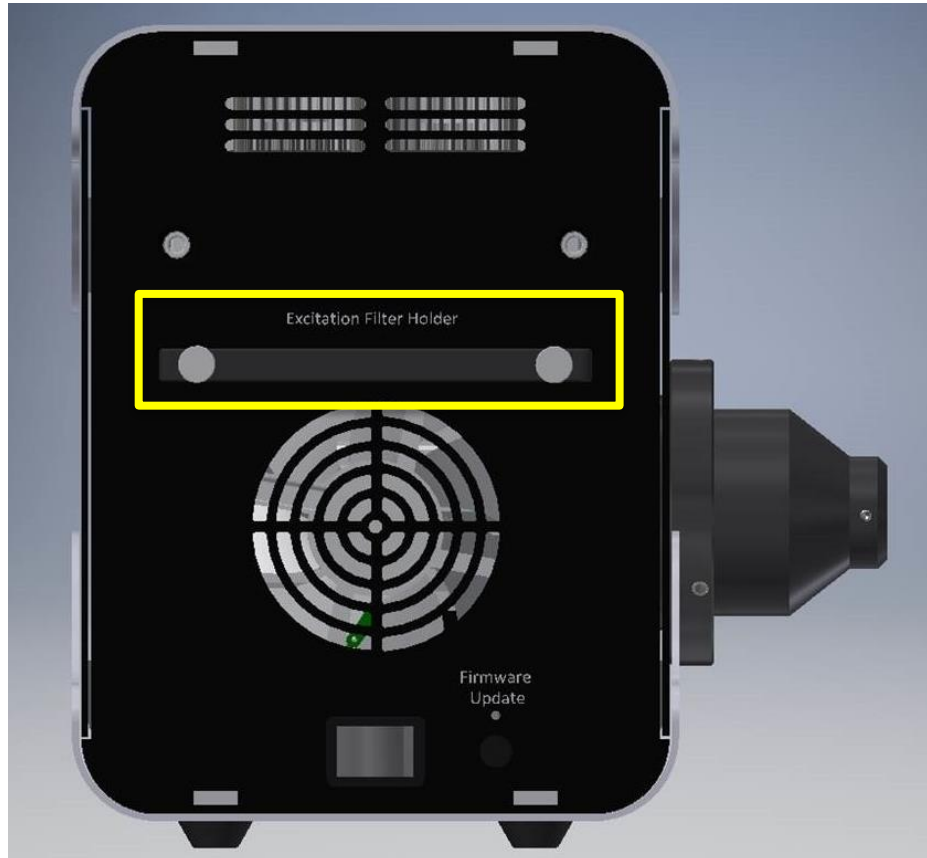

12.2.

The Excitation Filter Holder can be removed from the pE-800 by loosening the two thumbscrews.





12.3.

The Excitation Filter Holder has eight positions (one for each channel) to accept standard 25 mm excitation filters.

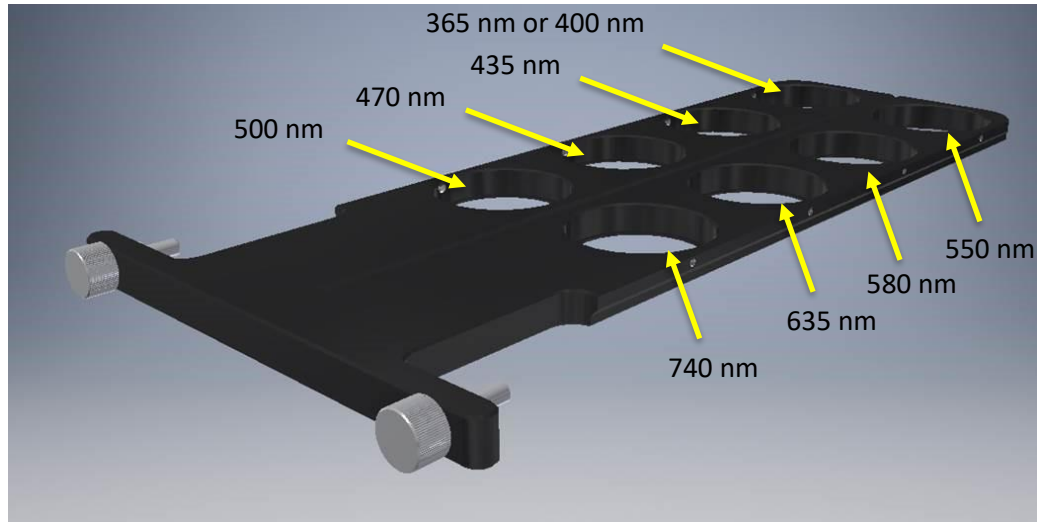

A label is fitted to the top side of the Excitation Filter Holder that indicates which position corresponds to each of the LEDs optical paths.

Filter position: Corresponding LED	
740 nm	500 nm
635 nm	470 nm
580 nm	435 nm
550 nm	365 nm
(This side faces LED Light sources)	

An example of the label fitted to an Excitation Filter Holder for an SB variant pE-800.

12.4.

The Excitation Filter Holder has been designed so that it is only possible to fit into the Light Source in one orientation.



Profile shape of the Excitation Filter Holder

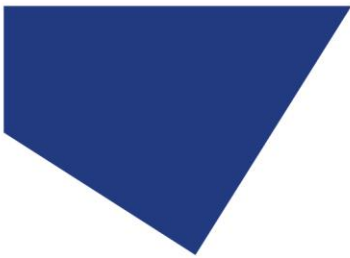

12.5.

To ensure the optimal performance of installed excitation filters, it is important that these are fitted in the correct orientation. The arrow in the below image shows the direction of light through the pE-800.



Most excitation filters have a directional arrow on the side. Excitation filters should be installed in the holder with this arrow pointing down (as shown in the image below).

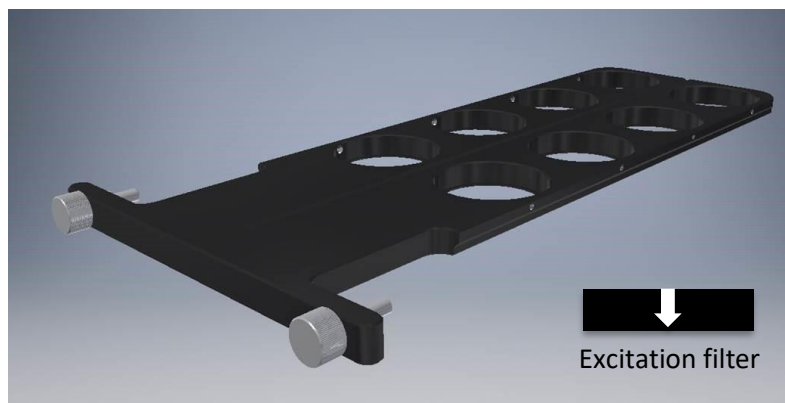



12.6.

The excitation filters are secured into the holder with a single grub screw per filter. A suitable hex key will be provided with the pE-800.

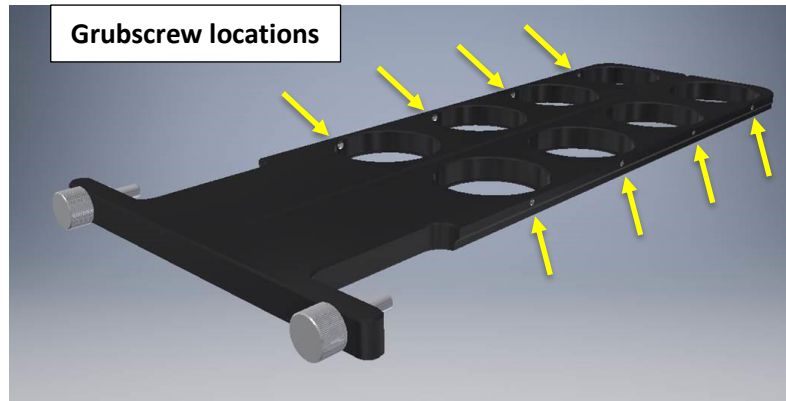

12.7.

The Excitation Filter Holder should be fully inserted into its channel and secured in position using the two thumbscrews. Take care not to over-tighten these.



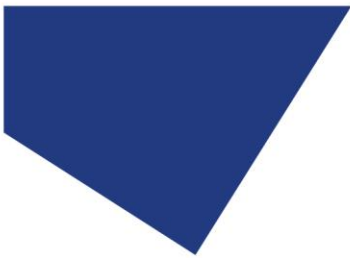

13. Software updates

13.1.

Occasionally it may be necessary to upgrade the firmware of the Light Source. This can be carried out in the field by following the steps below. Please contact support@cooled.com for the necessary firmware file.

13.2.

To upgrade the Light Source firmware using the LightBridge, the System needs to be put into Firmware update mode. Starting with the Light Source switched off, press and hold the firmware upgrade button whilst turning the Light Source on using the rocker switch. The firmware upgrade button is located through the small hole in the case above the indicator LED, at a depth of roughly 10 mm. A thin, non-metallic instrument will be required to reach this button.



13.3.

An indicator LED shall be illuminated from the firmware upgrade button to show that boot loader mode has been selected and the green power indicator LED will not be illuminated.

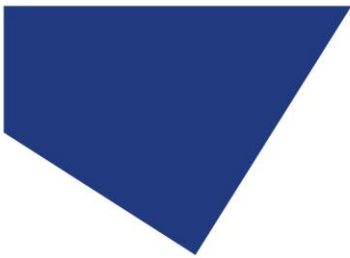

13.4.

When the LightBridge is opened the window below will be shown. Click on the box labelled “...” and select the required firmware file from the saved location on your PC.

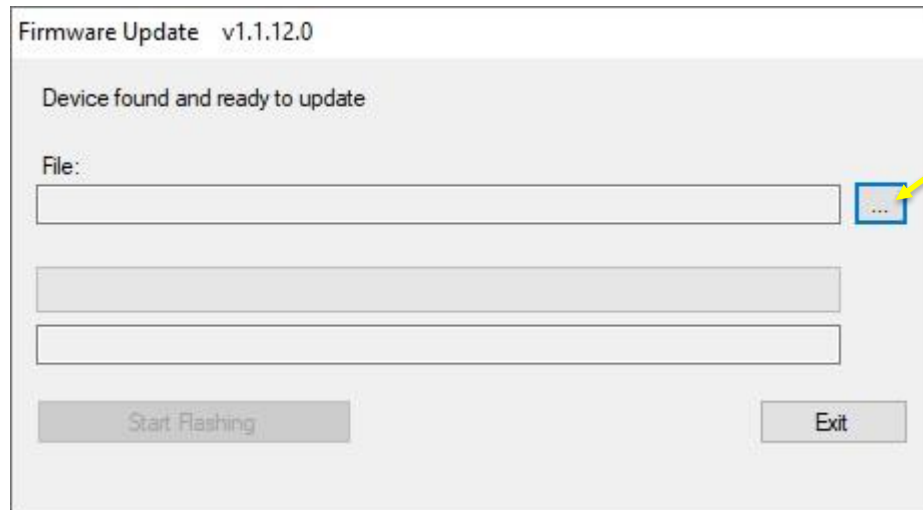

13.5.

Once the file has been selected, the file path length will populate the “File” box. To load the firmware file to the Light Source, press the “Start Flashing” button.

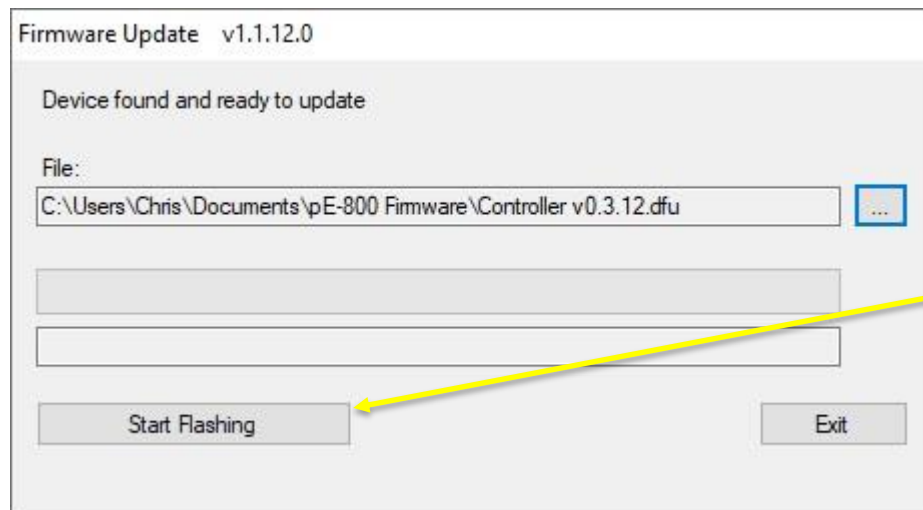



13.6.

Once the firmware programming has been completed a message will display “Programming complete”. Pressing the “Exit” button will return you to the default workbench page.

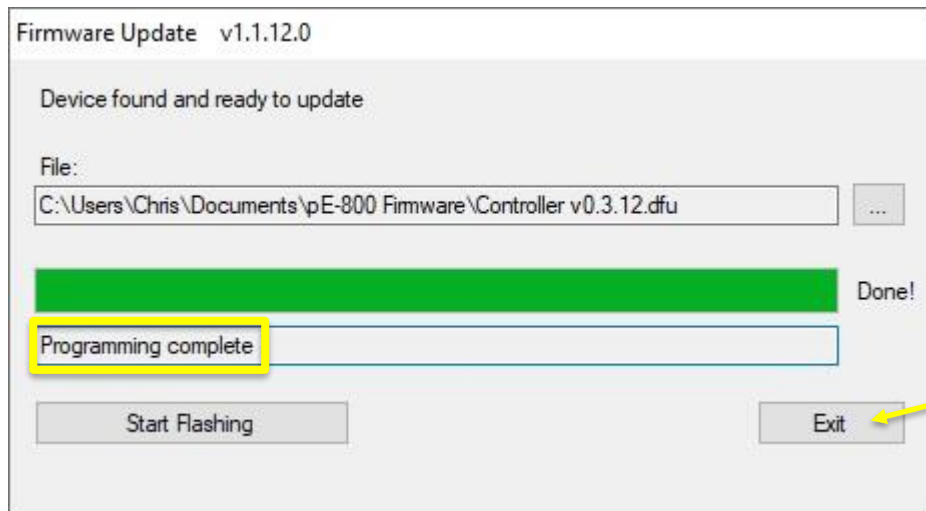

13.7.

The Light Source shall remain in Firmware Update mode, as indicated at the bottom of the LightBridge window, until the power is cycled using the rocker switch.



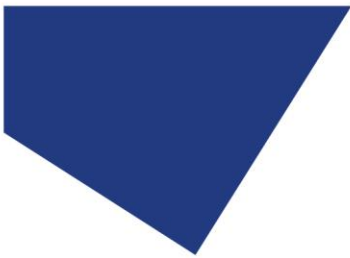

14. Additional information

14.1. Grounding pin

For particularly sensitive applications, such as Electrophysiology, it may be desirable ground the pE-800 to avoid any electrical interference. The pE-800 has a designated location to allow for a grounding pin to be attached. This is located on the right-hand side of the Light Source and has an internal M3 thread for connection.

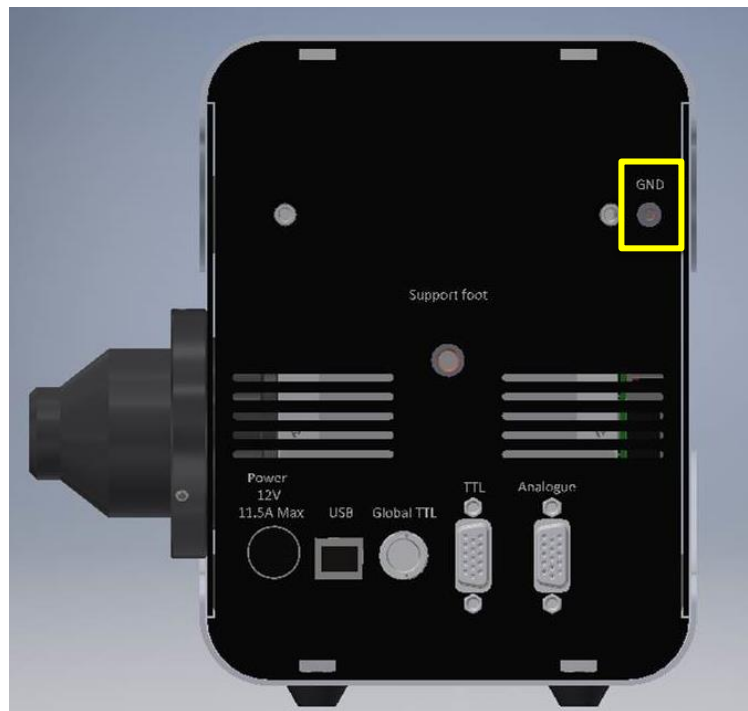

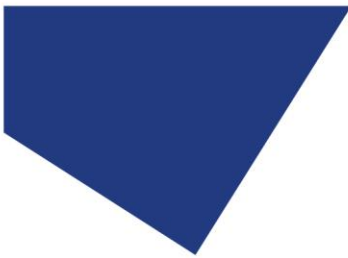

15. Product Specifications

15.1. Power Requirements

110-240V AC 50/60 Hz 2.0 A

15.2. Power Consumption

Eight wavelengths operating Max 135 W

15.3. Dimensions

pE-800 Light Source	261 mm (w) x 174 mm (d) x 174 mm (h)
-weight	3.51 kg
Power Supply	175 mm (w) x 72 mm (d) x 35 mm (h)
-weight	0.58 kg

15.4. Environmental Conditions

The pE-800 is designed for indoor use only.
Operating Altitude: ≤ 3,000 m asl
Working Temperature: 5 ~ 35 °C
Working Humidity: 20 % ~ 90 % RH non-condensing
Storage Temp. & Humidity: -40 ~ +85°C, 10 ~ 95 % RH
Input Voltage Range: 85 ~ 264 VAC
Input Frequency Range: 47 ~ 63 Hz
Pollution Degree 2 - Normally only nonconductive pollution occurs.
Temporary conductivity caused by condensation is to be expected.

16. Product Options and Order Codes

See website (www.cooled.com/products/) for full details of product options and order codes.



17. Warranty and Repairs

Please refer to CoolLED's current Warranty Policy available on our website www.coolled.com/support/coolled-warranty/. Although warranty terms are fixed at the time of ordering according to the terms and conditions of sale in place, the Warranty Policy may be subject to periodic change so please check to avoid confusion.

For any warranty queries or in the event of the product developing a fault, make contact with support@coolled.com for further assistance. You shall be asked to provide your microscope make and model, the product serial number and a brief description of the issue. You shall then be issued with a Support Case to manage your issue.

18. Compliance and Environmental

For current compliance statements and environmental information please refer to our website www.coolled.com/support/environment/.

18.1. CoolLED's Recycling Program

At CoolLED, we recognise the importance of preserving the global environment. We are proud to provide a Recycling Program that enables CoolLED customers and end-users to send back used CoolLED Light Sources for recycling, free of charge.

Together we can reduce the burden on our environment through responsible disposal and recycling of end-of-life Light Sources. You can help us by filling in our online contact form and providing us with your contact details and the serial number of the CoolLED Light Source that you wish to return, and we will collect it free of charge.

If you are taking delivery of a replacement CoolLED Light Source, why not arrange to send the old one back in the packaging box of the new one?

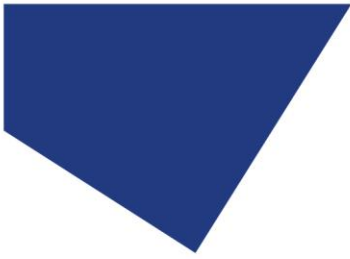

19. Contact Details

19.1. Headquarters Address

CoolLED Ltd
26 Focus Way
Andover
Hants
SP10 5NY
UK

19.2. Telephone

Worldwide - +44 (0)1264 323040
USA & Canada - 1-800-877-0128

19.3. Fax

Worldwide - +44 (0)1264 723897

19.4. Email

General - info@cooled.com

19.5. Website

www.cooled.com



20. Appendix 1

Installing your CoolLED system on Windows machines

20.1. Windows 10

When you first plug your CoolLED system into your PC with the USB cable, Windows will automatically install the driver files.

20.2. Windows 8 and earlier

The first time your CoolLED Illumination System is connected to your PC via USB you shall need to follow the steps below to allow a virtual COM port to be assigned

20.2.1.

The CoolLED pE Driver needs to be downloaded from the CoolLED website. This file can be found on the following page:

www.coolled.com/support/imaging-software/

Once downloaded this needs to be saved somewhere on your PC.

20.2.2.

Navigate to the 'Device manager'.

The CoolLED Illumination System should initially be listed under 'Other devices' as 'USB Virtual Serial Port' with a yellow exclamation mark icon. Right-click on this and select the 'Update Driver Software...' option from the list.

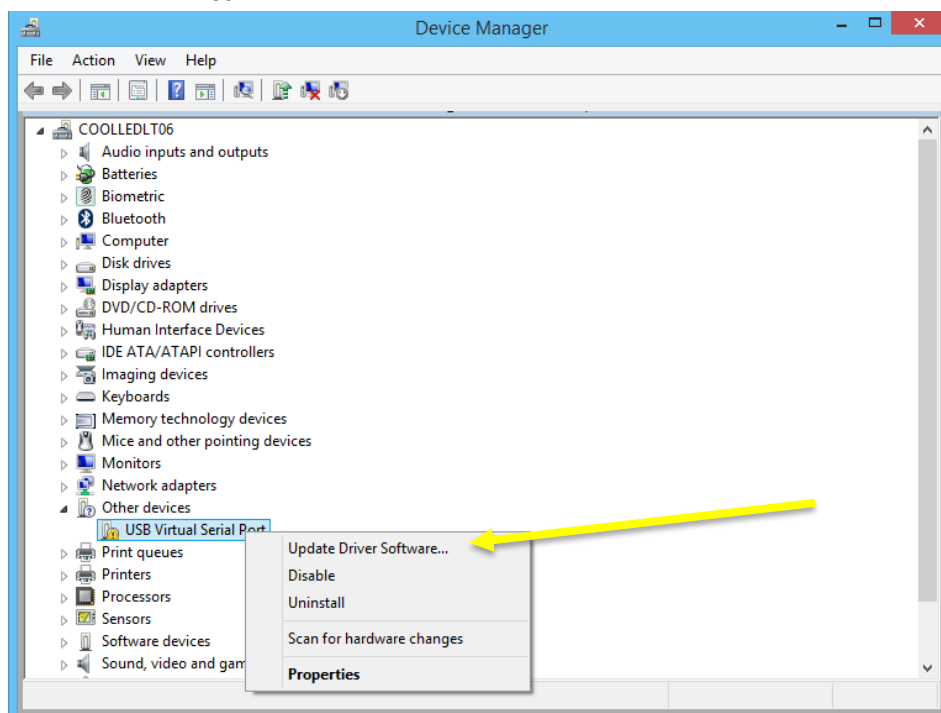

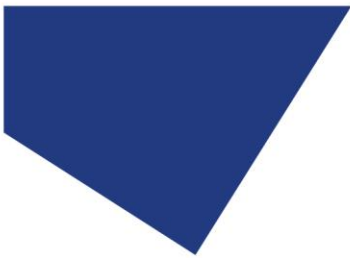

20.2.3.

The window shown below will be displayed. Select the 'Browse my computer for driver software' option.

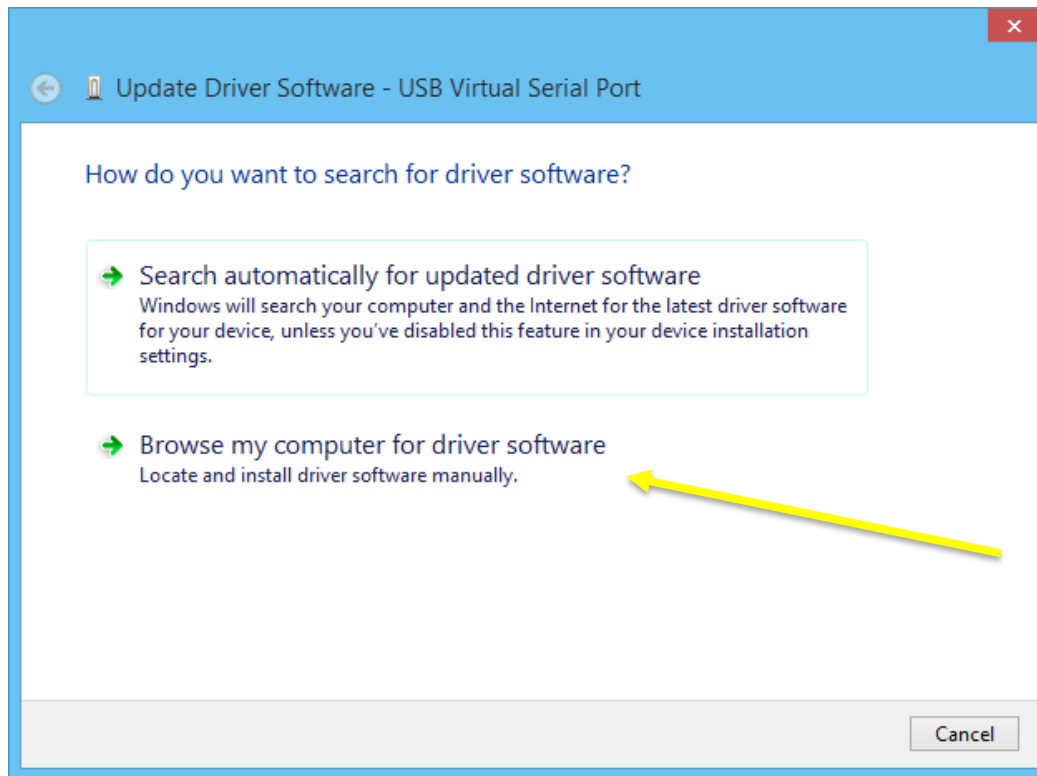

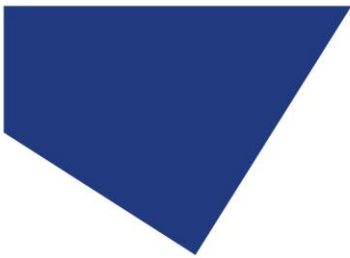

20.2.4.

Select the 'Let me pick from a list of device drivers on my computer'.

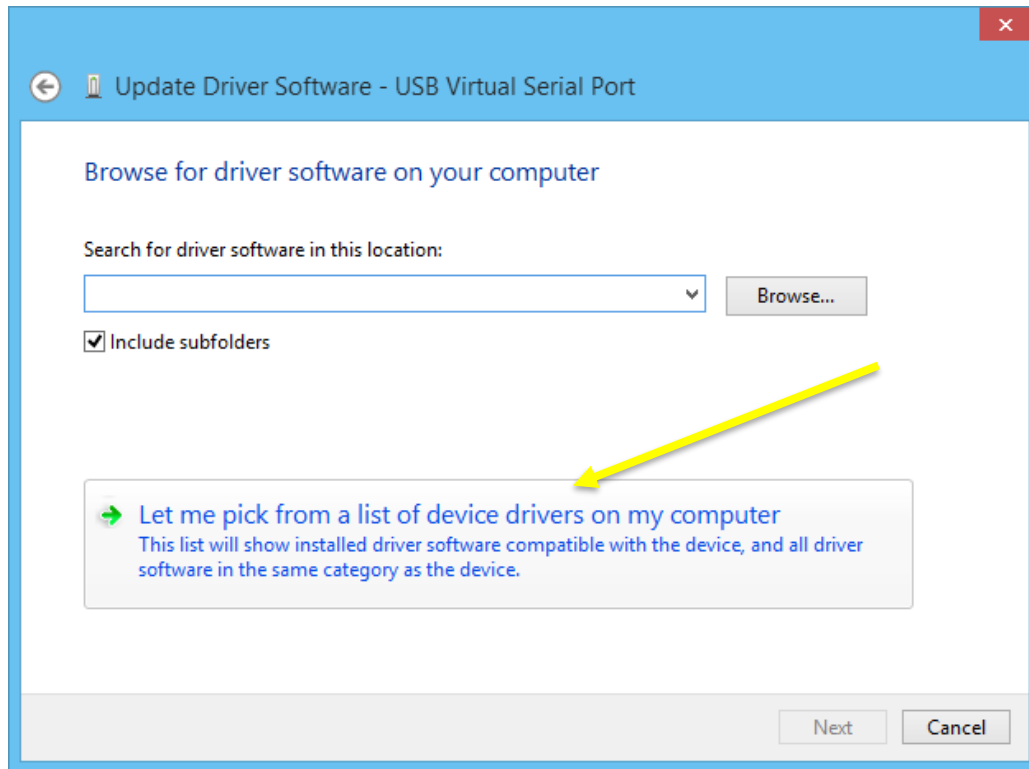



20.2.5.

Select 'Port (COM & LPT)' and then click the 'Next' button.

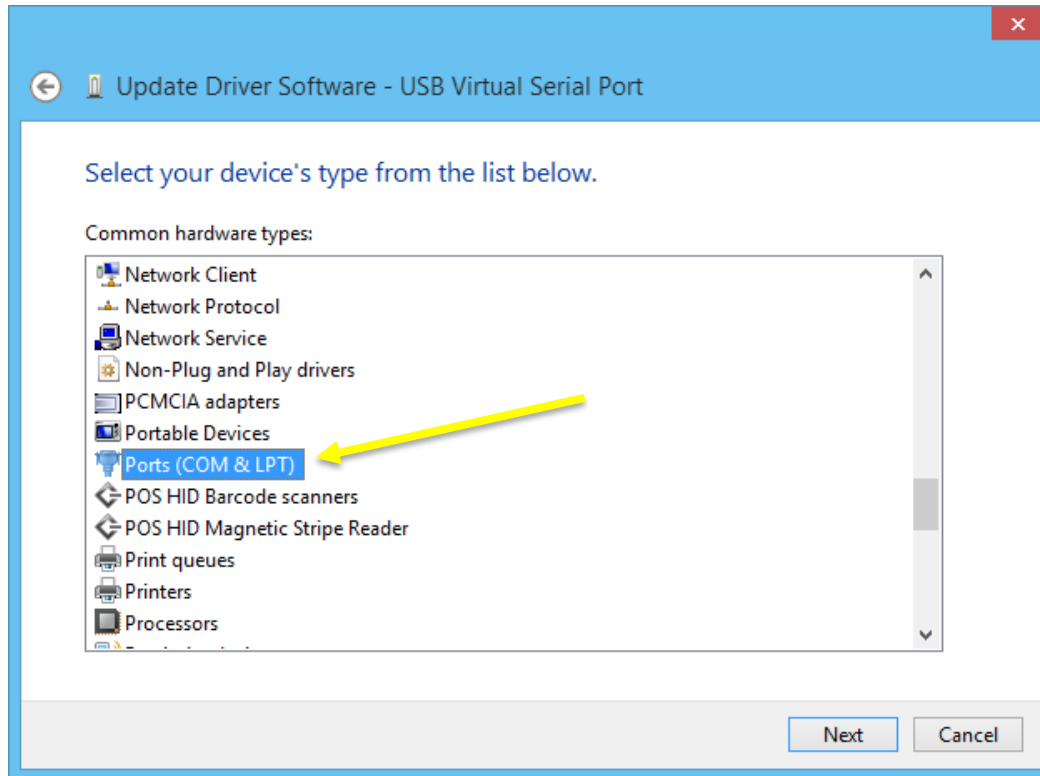

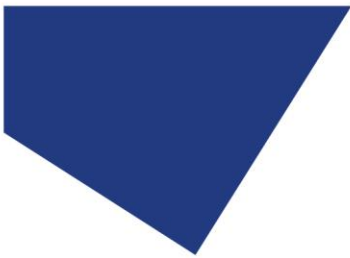

20.2.6.

Select the '(Standard port types)' from the 'Manufacturer' field, select 'Communications Port' from the 'Model' field and press the 'Have Disk...' button.

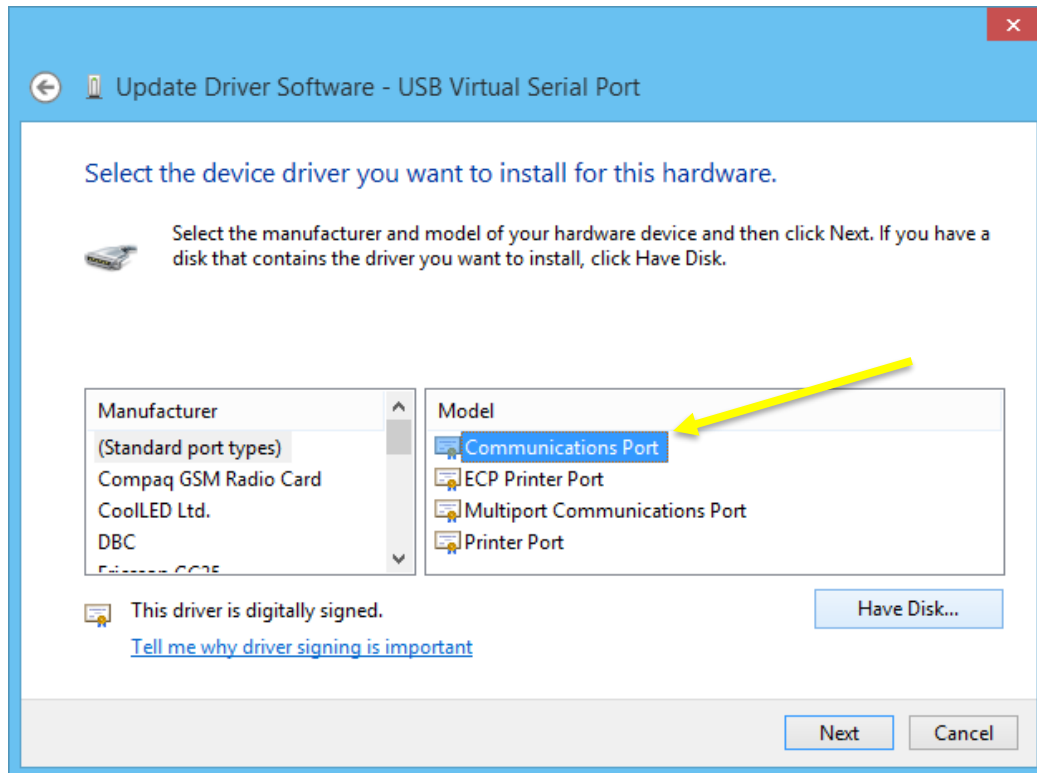

20.2.7.

Press the 'Browse...' button on the 'Install From Disk' window.

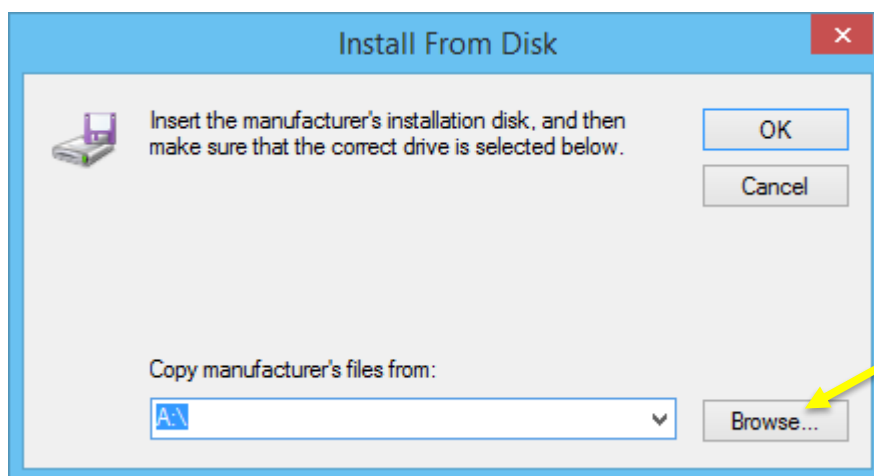



Locate the CoolLED pE Driver file and press the 'Open' button.

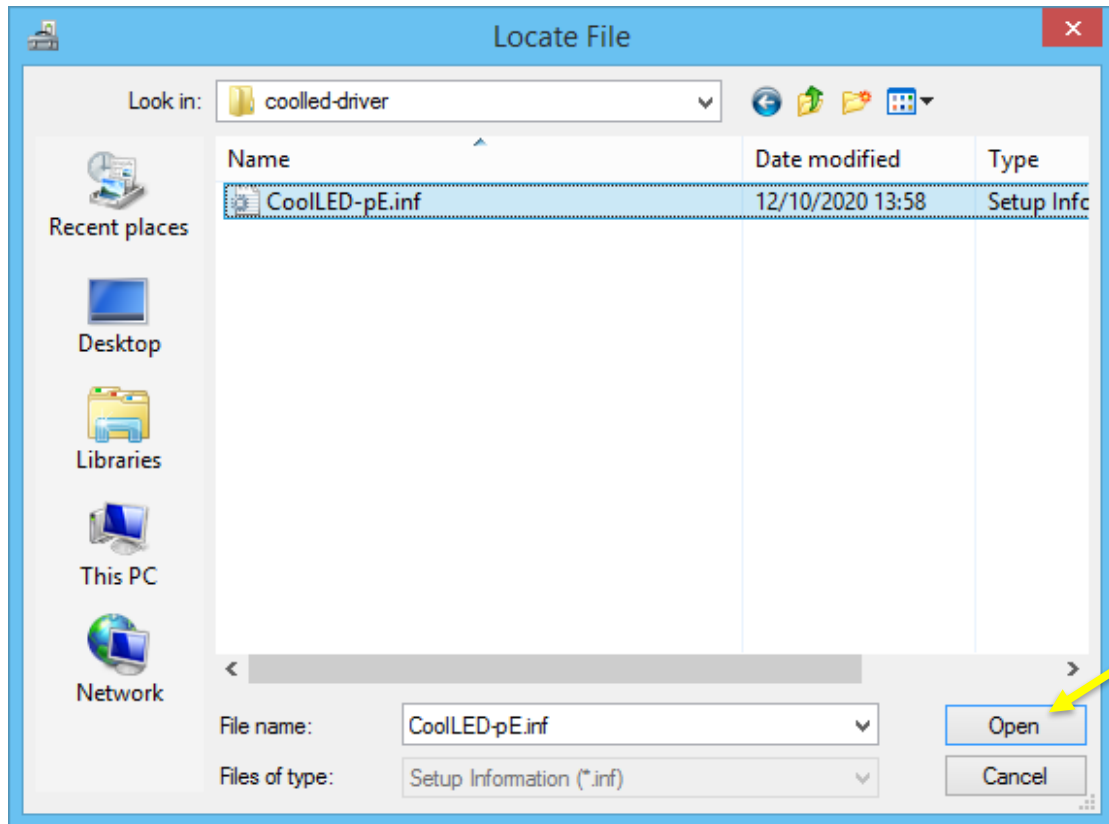

The 'Copy manufacturer's files from:' field will now be populated with the server location of the pE-Driver. Press 'OK' to confirm this.



20.2.8.

Select 'CoolLED USB Virtual Serial Port A' in the 'Model' field and press 'Next'.

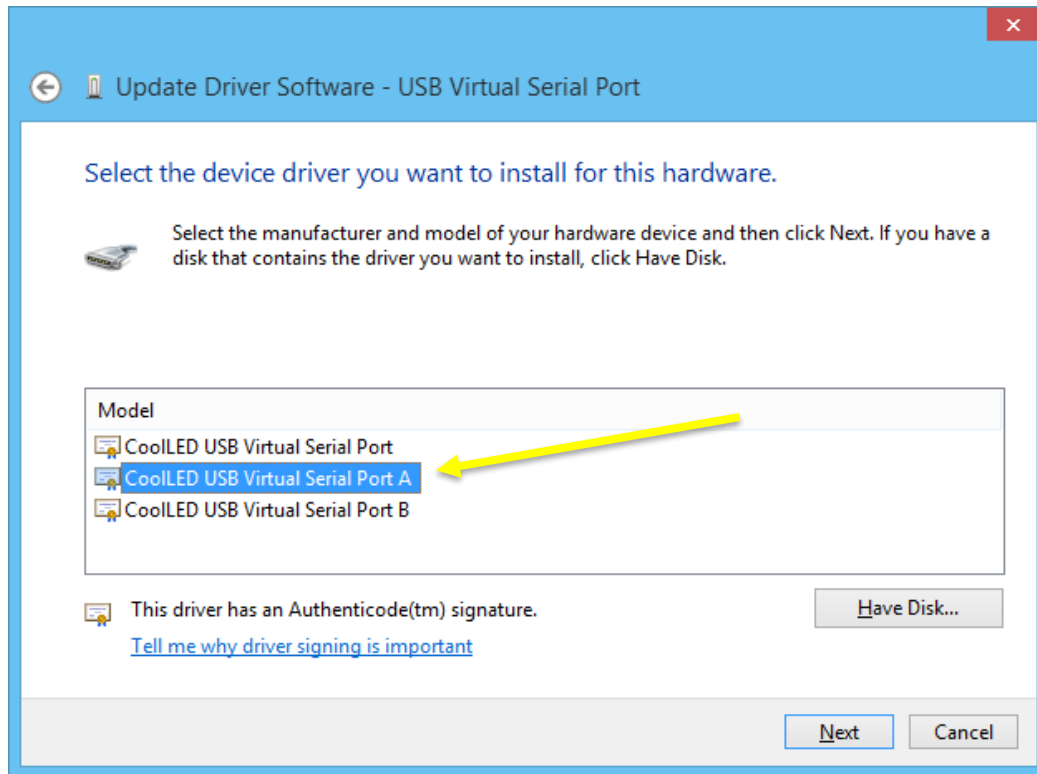

20.2.9.

A warning window will be displayed. Press the 'Yes' button to confirm.

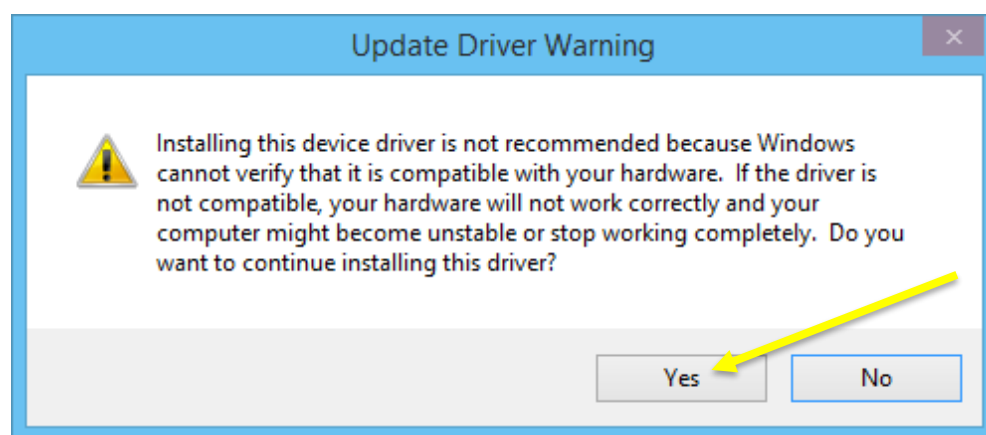

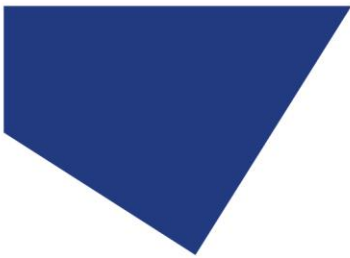

20.2.10.

A Windows security page may be displayed at this stage. Press the check box labelled 'Always trust software from "CoolLED Ltd"' and press the 'Install' button.

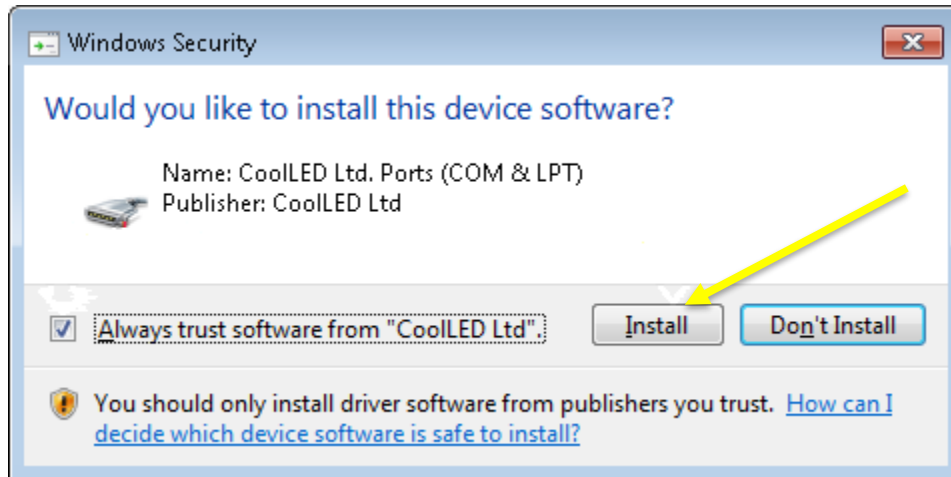

20.2.11.

A window will be displayed confirming that the driver software has been updated. Press the 'Close' button. The pE-800 will now be ready to use via USB.

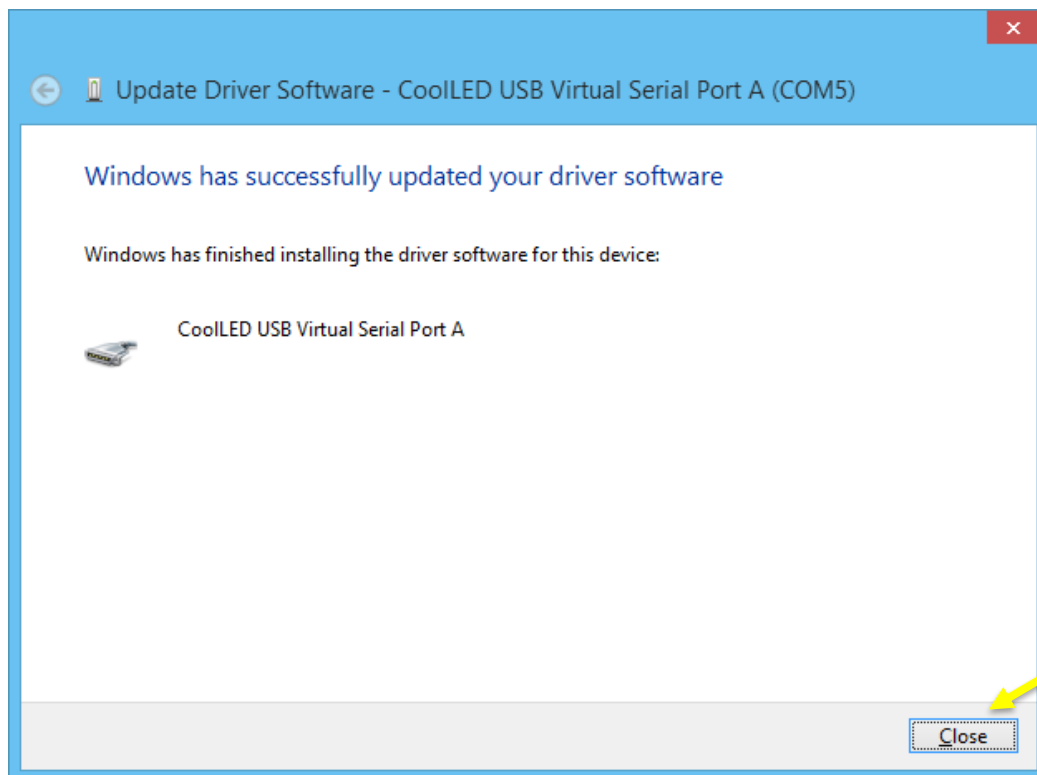



20.2.12.

With the pE-800 now recognised by Windows, the specific Virtual COM port that has been assigned can be found in 'Device Manager' by expanding the 'Ports (COM & LPT)' field. The pE-800 will be listed as 'CoolLED USB Virtual Serial Port A'.

