



*Patch Clamp Amplifier*

2400

# INSTRUCTION MANUAL FOR PATCH CLAMP AMPLIFIER MODEL 2400

*Each Patch Clamp Amplifier is delivered  
complete with:*

*A headstage probe (purchased separately)  
Model Cell  
5" Model Cell connector cable  
Rack Mount Hardware*

*Version 15.0  
May 2025*

**A-M Systems, Inc.  
PO Box 850  
Carlsborg, WA 98324  
U.S.A.  
360-683-8300 . 800-426-1306  
FAX: 360-683-3525  
<http://www.a-msystems.com>**

### Disclaimer

THIS EQUIPMENT IS NOT INTENDED FOR USE WITH HUMAN SUBJECTS IN ANY WAY.

### Document

The information contained in this manual was as accurate as possible at the time of publishing, but is subject to change without notice and should not be construed as a commitment by A-M Systems, Inc. Changes may have been made to the hardware or firmware it describes since publications. A-M Systems, Inc. reserves the right to change specifications as required. For the latest information please check our website (<http://www.a-msystems.com>) or contact A-M Systems, Inc. directly.

Manual Product Number  
880004

Manual Document Number  
5027600 Rev 15

All rights reserved. No part of this document may be reproduced by any means without the prior written permission of A-M Systems, Inc.

### Safety

This instrument is provided with terminal for protective grounding. Before applying power, verify that the correct safety precautions are taken (see the following warnings). In addition, note the external markings on the instrument that are described under Safety Symbols. Do not operate the instrument with its cover removed. Replace fuse only with specified type.

### Supply Voltage

This equipment is customized at the factory for line voltages of the county of destination. The required line voltage is indicated on the rear panel.

### WARNING

Do not attach a line voltage that does not match the line voltage specified on the rear panel.

Before turning on the instrument, you must connect the protective earth terminal of the instrument to the protective earth conductor of the (mains) power cord. The mains plug must only be inserted in a socket outlet with a protective earth contact.

Service should be performed by trained personnel only. To avoid dangerous electric shock, do not perform any service unless qualified to do so.

Do not operate the instrument in the presence of flammable gases or fumes. Operation of any electrical instrument in such an environment constitutes a definite safety hazard.

### Safety Symbols



The product is marked with this symbol when it is necessary for you to refer to the instruction manual in order to protect against damage to the product.

### WARNING

The Warning symbol calls attention to a procedure or practice, which, if not correctly performed could result in injury. Do not proceed beyond a Warning symbol until the indicated conditions are fully understood and met.

### CAUTION

The Caution symbol calls attention to a procedure or practice, which, if not correctly performed could result in damage to the product. Do not proceed beyond a caution until the indicated conditions are fully understood and met.

## Table of Contents

Table of Contents.....	iv	Membrane Current Output Range.....	40
List of Tables and Figures.....	v	Membrane Voltage Output Range .....	40
About This Manual .....	1	Filter.....	40
Chapter Overview .....	1	RMS Meter.....	40
Conventions .....	1	Capacity Compensation .....	40
Quick Overview .....	2	Whole Cell Compensation .....	41
Getting Started .....	4	Series Resistance.....	41
Basic Connections.....	4	DC Balance .....	41
Functional Test.....	5	Hold Command.....	41
Single Channel Recordings.....	6	Offset Command.....	41
Whole Cell Recordings .....	11	Speed Test Command .....	41
Current Clamp Recordings .....	17	Vcomp Command .....	41
Instrument Operation .....	20	Iresist Command .....	41
Probe .....	20	External Command: Voltage Clamp .....	42
Power .....	21	External Command: Current Clamp .....	42
Meter .....	21	Power Supply Requirements.....	42
Mode .....	22	Physical Dimensions.....	43
Capacity Compensation .....	24	Powered Probe Input.....	43
Fixed Outputs.....	24	Warranty .....	44
Whole Cell Compensation .....	25	Index .....	46
Series Resistance.....	25		
Clamp Signal.....	27		
Probe Input.....	29		
Bandwidth.....	29		
Bath Input.....	30		
Telegraph Outputs.....	30		
AC Power Input .....	32		
Model Cell .....	32		
Connecting to a Computer .....	33		
Troubleshooting .....	34		
Circuit Description.....	37		
Probe .....	37		
Clamp Signal.....	37		
Current Clamp.....	37		
Membrane Voltage Output .....	38		
Compensation .....	38		
Specifications.....	39		
Input Impedance.....	39		
Output Impedance.....	39		
Input Current/Voltage ratings .....	39		
Probe Gain and Bandwidth .....	39		
Probe Case .....	39		
Maximum Instrument Noise .....	40		
Internal Bandwidth.....	40		

## List of Tables and Figures

Figure 1. Model Cell Schematic .....	6
Figure 2. Electrode in the air.....	8
Figure 3. Electrode in the bath.....	8
Figure 4. Offset adjustment trace.....	9
Figure 5. Patch seal trace .....	10
Figure 6. Patch seal with transients compensated.....	10
Figure 7. Whole cell recording before capacity compensation .....	14
Figure 8. Whole cell recording with fast transients cancelled .....	14
Figure 9. Whole cell recording with all transients cancelled .....	14
Figure 10. Whole cell recording with series resistance controls turned on to 90%	15
Figure 11. The Probe.....	20
Figure 12. Power switch .....	21
Figure 13. Meter.....	21
Figure 14. Mode.....	22
Figure 15. Probe Gain .....	22
Figure 16. Filter .....	23
Figure 17. Gain .....	23
Figure 18. Mode Output.....	23
Figure 19. Capacity Compensation.....	24
Figure 20. Fixed outputs .....	24
Figure 21. Whole Cell Compensation.....	25
Figure 22. Whole cell recording before compensation .....	25
Figure 23. Whole cell recording after whole cell compensation.....	25
Figure 24. Series Resistance controls .....	25
Figure 25. Voltage clamp series resistance controls.....	26
Figure 26. Whole cell recordings with RsPre at 90% .....	26
Figure 27. Whole cell recordings with RsComp at 90% .....	26
Figure 28. Whole cell recording with RsComp and RsPre at 90%.....	26
Figure 29. Whole cell recording with RsComp and RsPre at 90% and Whole Cell parameters readjusted.....	27
Figure 30. Current clamp Bridge Balance	27

Figure 31. Hold and Offset command control .....	27
Figure 32. Tracking Controls.....	28
Figure 33. Command Filter.....	28
Figure 34. External Command input.....	28
Figure 35. Probe input.....	29
Figure 36. Bath Input .....	29
Figure 37. Telegraph Outputs .....	30
Figure 38. AC Power Input.....	32
Figure 39. Model Cell .....	32
Figure 40. Model 2400 Block Diagram ...	35
Figure 41. Probe block diagram.....	37

Table 1 Typography Conventions.....	1
Table 2 Minimal equipment.....	4
Table 3 Front panel test settings .....	5
Table 4 Typical noise levels .....	6
Table 5 Single channel set-up .....	7
Table 6 Probe Gain and Bath VClamp .....	8
Table 7 Whole Cell set-up .....	12
Table 8 Current clamp set-up.....	17
Table 9 Probe resistor values .....	19
Table 10 Probe resistor values .....	20
Table 11 Probe Pin-out .....	21
Table 12 Meter Display settings .....	22
Table 13 Probe resistor current gain .....	23
Table 14 Mode output units .....	24
Table 15 External Clamp Signal Scaling..	29
Table 16 Noise telegraph output.....	30
Table 17 Gain telegraph output.....	30
Table 18 Filter telegraph output.....	31
Table 19 Mode telegraph output.....	31
Table 20 Error telegraph output.....	32
Table 21 Common Problems .....	34

## About This Manual

### Chapter Overview

This manual is designed to provide the researcher with the basic features of Model 2400 in order to proceed to experiments as quickly as possible. For this reason we have left the detailed descriptions of each function towards the end of the manual. Chapter 1 will review the instrument's capabilities. Chapter 2 will list the necessary steps to start collecting data, in each of the following situations: single channel, whole cell, or current clamp mode. Chapter 3 provides description of the amplifier's features and controls. Chapter 4 describes how to interface the Model 2400 with various software packages. Chapter 5 lists some simple steps to identify and solve common problems encountered in electrophysiological recording. Chapter 6 provides a description of the amplifier's circuitry.

Although this manual provides the basics on using our patch clamp amplifier, it assumes the researcher has some knowledge of patch clamp techniques. For a more in-depth discussion of patch clamp recording we refer you to "Single-Channel Recording", edited by Bert Sackmann and Erwin Neher (ISBN 030644870X, Plenum Press), and "Voltage and patch clamping with microelectrodes" edited by Thomas G. Smith, Jr. et al. (ISBN 0683077732, American Physiological Society).

### Conventions

**Table 1** Typography Conventions

This manual uses certain conventions to indicate elements of the Model 2400's user interface. The following table shows some examples:

---

Named panel controls or connectors	Adjust <b>OFFSET</b> until <b>Im</b> reads zero on the oscilloscope.
Knobs within named outlined area on the front panel follow the outlined area after a colon	Set <b>MODE:GAIN</b> to 100, for an overall gain of 10mV/pA
Values on the meter	The meter should display <i>0.05 pA</i> .
Dual knobs. (i) refers to the inner knob and (o) refers to the outer knob	Alternately adjust <b>FAST2-GAIN(i)</b> and <b>FAST2-LAG(o)</b> until the transient is minimized

---

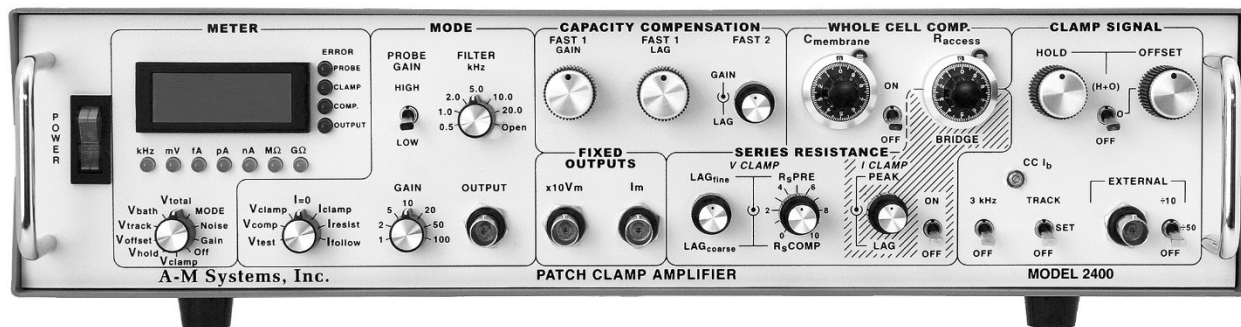

## Quick Overview

The Model 2400 is a low noise, full featured intracellular/extracellular amplifier designed for voltage or current clamping using patch electrodes on single channels or whole cells. Its unique design allows fast intracellular current clamp measurements with sharp electrodes. Advanced circuit design techniques using field programmable gate arrays eliminated noisy microprocessors.

Amplifier current gain is extremely flexible as it can accept any of four switchable resistive feedback probes. Each probe has two feedback resistors selected from the following values: 10M, 100M, 1G, and 10G. The main amplifier automatically recognizes the feedback resistor and adjusts internal gains to always provide the correct values to the meter and correct signal magnitude at the outputs. The wide range of feedback resistors means currents from 1 fA to 1  $\mu$ A can be recorded with outputs of 1mV/nA to 10mV/fA.

Unlike most patch clamp amplifiers, the Model 2400 has a voltage follower in the probe. This allows this amplifier to be a true fast current clamp amplifier with no instability. An integrated 6 position four pole low pass Bessel filter provides flexible signal conditioning. Dual fine tuning capacity compensation is available to eliminate virtually all electrode-induced transients. Calibrated whole cell compensation provides easy display of membrane capacitance and access resistance.

A host of command potentials are integrated internally within the model 2400, including an automatic tracking command to zero the membrane current, manual controls for offset and holding potentials, and an easily readable digital display. For signals that are more complicated, an external command input with different scaling factors is available for use with any signal source.

Standard stimulation protocols are integrated into the **MODE** switch. Membrane voltages can be monitored in 3 modes: **Iclamp**, **Iresist**, and **Ifollow**. **Iclamp** is the generic current clamp mode where clamp signals can be customized using the front panel controls or via the external clamp input. **Iresist** sends a fixed amplitude square wave for easy measurement of electrode resistance. **Ifollow** configures the probe to be a simple voltage follower to monitor membrane voltage. Currents can be monitored in 3 modes: **Vcomp**, **Vclamp**, and **Vtest**. **Vcomp** is a voltage clamp mode with a fixed amplitude square wave clamping signal, useful for searching for cells and adjusting the compensation controls. **Vclamp** is the generic voltage clamp mode where clamp signals can be customized using the front panel controls or via the external clamp input. **VTest** sends a square wave of current into the probe for testing the frequency response of the probe.

A digital meter provides accurate values of command signals and membrane currents or voltages, the true RMS noise of the amplifier and experimental setup, the cut off frequency of the low pass filter, and the overall gain of the amplifier plus probe.

Series resistance compensation provides the researcher with the option of introducing either or both predictive and corrective compensation from zero to 100%. Fine and coarse controls for lag provide sensitive control to minimize oscillation produced by compensation close to 100%.

Separate compensation controls exist for eliminating transients seen during current clamp experiments when the bridge balance is used.

Telegraph outputs provide analog voltage equivalents of front panel settings including error conditions, amplifier mode and gain,  $C_{\text{membrane}}$ , RMS noise, and low pass filter cut-off value. These telegraphs allow the Model 2400's front panel settings to be automatically recorded by your system software.

For those who need extra large bandwidths, the raw bandwidth of the entire amplifier may be adjusted via a rear panel potentiometer.

A second powered probe input is available for use as a bath signal input.



# 2

## Getting Started

Patch clamp amplifiers can seem complicated. This chapter is designed to take you through an experiment with the minimal amount of instructions necessary. If you are familiar with patch clamp recording already, you may want to skip ahead to Chapter 3 where each feature of the Model 2400 is described.

When you receive your Model 2400 confirm that everything in the packing list is included. Make sure there are no obvious signs of internal damage, such as rattling. Pick up the amplifier and tilt in gently from side to side, and listen for anything that might be loose.

### WARNING

Check that the correct voltage for your country is shown on the back of the unit. The Model 2100 should be delivered with the appropriate mains power voltage set, at either 100-120 volts or 220-240 volts. The setting is indicated on the back panel to just to the side of the power input. If the wrong voltage or no voltage is indicated on the rear panel contact A-M Systems, Inc. immediately

**Table 2 Minimal equipment**

In this chapter you will need the equipment listed in the following table.

---

A-M Systems, Inc. Model 2400 Patch Clamp Amplifier

A-M Systems, Inc. Model Cell

An oscilloscope

---

### **Basic Connections**

Connect the power cable to the **AC POWER INPUT** on the rear of the unit and to an approved outlet. Do not turn the Model 2400 on. Connect the probe cable to the **PROBE** input on the rear of the unit. Connect a BNC cable from the **MODE OUPUT** to an oscilloscope.

### CAUTION

Be certain to properly ground yourself whenever you handle the probe as it is susceptible to electric static discharge (ESD). ESD can cause immediate or subtle damage to sensitive electronic parts. You can reduce the chances of ESD damage by:

- Only connecting the probe to the amplifier when the amplifier is off.
- Always grounding yourself by touching the handle of the amplifier, or another grounded piece of metal prior to handling the probe.
- Avoiding extraneous walking around while holding the electrode holder or model cell, especially if you are on carpet or during conditions of low temperature and low humidity.

## Functional Test

This simple test will check to see if the most essential components of the amplifier are working.

With the amplifier turned off, set the front panel controls as follows:

**Table 3** Front panel test settings

<b>METER</b> (knob)	<b>Noise</b>
<b>MODE</b>	<b>Vclamp</b>
<b>MODE PROBE GAIN</b>	<b>LOW</b>
<b>MODE: GAIN</b>	<b>1</b>
<b>MODE: FILTER</b>	Open
<b>CAPACITY COMPENSATION: FAST1: Gain</b>	Fully counterclockwise
<b>CAPACITY COMPENSATION: FAST1: Lag</b>	Fully counterclockwise
<b>CAPACITY COMPENSATION: FAST2</b>	Fully counterclockwise (inner and outer knob)
<b>WHOLE CELL COMPENSATION</b>	<b>OFF</b>
<b>SERIES RESISTANCE</b>	<b>OFF</b>
<b>CLAMP SIGNAL</b> (Hold/Offset Toggle)	<b>OFF</b>
<b>CLAMP SIGNAL: 3kHz</b>	<b>OFF</b>
<b>CLAMP SIGNAL</b> (tracking)	<b>OFF</b>
<b>CLAMP SIGNAL: EXTERNAL</b>	<b>OFF</b>

Place the probe in a Faraday cage (this can be as simple as surrounding the probe with aluminum foil and grounding the foil). Note: the BNC shields on the front panel make good ground connectors.

Depress the Power switch.

The power switch should light up and the meter should display the noise value.

Step the **FILTER** knob counterclockwise through the decreasing cut-off frequency positions and the noise value should drop. Select the 1.0kHz position. The meter now displays the RMS noise at 1kHz.

Switch the **PROBE GAIN** between HIGH and LOW. You should see the noise value on the meter alternate between two different values. The values will depend on the type of probe you have. The following table gives expected values of noise for each type of feedback resistor. At any time, you can change **METER** to **GAIN**, and **MODE: GAIN** to **1**, then the meter will display the current gain of the probe. You can then refer to the table to determine the value of resistor in each **PROBE GAIN** setting.

**Table 4** Typical noise levels

Feedback Resistor	Typical RMS noise (@1kHz)	Probe Gain
10M	0.003 nA	10mV/nA
100M	0.5 pA	100mV/nA
1G	0.17 pA	1mV/pA
10G	0.08 pA	10mV/pA

If you were able to complete the preceding procedures, then most of the main amplifier is functioning and you have a valid connection to the probe. If the noise is much larger than the values displayed in Table 4, confirm that the input connector is not touching a ground source. If the noise remains excessive, you may have a broken probe, continue with the rest of this section to see if any other features are malfunctioning. If the noise is much lower than listed in the table, confirm that the probe is connected properly. If the probe is not connected to the amplifier the **PROBE** error light will be lit.

The following will test the components within the probe. Change the **MODE** knob to **Vtest**. This will inject a biphasic 4nA peak to peak (p-p) square wave at 60Hz (0.2nA p-p with probe gain high).

Set your oscilloscope to 1V/Division, 5ms/div, and triggered on channel 1. On your oscilloscope, you should see a square wave reflecting the gain of your probe.

If you do not see a square wave, check to see that the probe cable is firmly screwed into the rear panel. You may need to reduce the vertical sensitivity on the oscilloscope.

If you see a square wave, then the probe is working. If you do not have a square wave on the output, re-check all connections, and confirm there is no error indication on the front panel. If problems persist please call customer service at A-M Systems, Inc.

### **Single Channel Recordings**

This section will walk you through the features of the Model 2400 that are commonly used in a typical single channel recording experiment. In this section we will be using the model cell, but after you become familiar with the controls on the Model 2400, you will be able to substitute a real electrode and cell for the model cell.

**Figure 1.** Model Cell Schematic

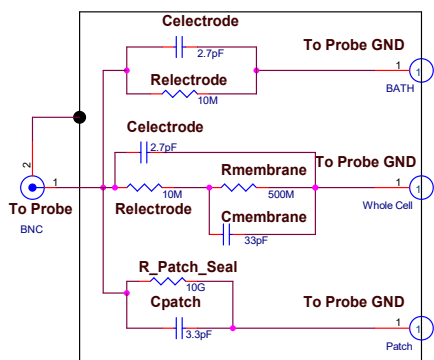

The model cell is an electrically equivalent circuit of a simplified electrode/bath/cell interface. Figure 1 shows the schematic diagram of the model cell. The component names indicate which part of the electrode, bath, or cell they represent.

Equipment you will need in this section is the Model 2400 with probe, the model cell, and an oscilloscope. In a real experiment, you would also need a pulse generator, a cell chamber (bath), a cell, a manipulator, and something to record your data.

## Set-Up

Set the controls on the front panel as follows:

**Table 5** Single channel set-up

<b>METER</b> (knob)	<b>MODE</b>
<b>MODE</b>	<b>Vclamp</b>
<b>MODE: PROBE GAIN</b>	<b>HIGH</b>
<b>MODE: GAIN</b>	<b>1</b>
<b>MODE: FILTER</b>	Open
<b>CAPACITY COMPENSATION: FAST1: Gain</b>	Fully counterclockwise
<b>CAPACITY COMPENSATION: FAST1: Lag</b>	Fully counterclockwise
<b>CAPACITY COMPENSATION: FAST2</b>	Fully counterclockwise (inner and outer knob)
<b>WHOLE CELL COMPENSATION</b>	<b>OFF</b>
<b>SERIES RESISTANCE</b>	<b>OFF</b>
<b>CLAMP SIGNAL</b> (Hold/Offset Toggle)	<b>OFF</b>
<b>CLAMP SIGNAL: 3kHz</b>	<b>OFF</b>
<b>CLAMP SIGNAL</b> (tracking)	<b>OFF</b>
<b>CLAMP SIGNAL: EXTERNAL</b>	<b>OFF</b>

Connect the **MODE: OUTPUT** to channel 1 on your oscilloscope. Set the oscilloscope to 1V/division, 2ms/division, and trigger on channel 1. Attach the probe to your micromanipulator located within the recording (Faraday) chamber. Attach the model cell to the probe's BNC connector, but leave the ground pin unconnected.

## Entering the Bath

Normally as you approach the cell you would provide a square wave voltage clamp signal (for example, 10mV, 60Hz). In theory, before you enter the bath the current resulting from the square wave is essentially zero since you are clamping an extremely large resistance (from the electrode through the air to your reference electrode) (Figure 2). Small transients at the frequency of the clamping signal might be observed. When the electrode enters the bath, the resistance seen by the amplifier will suddenly drop to the resistance of the electrode. This will mean there will be a large increase in current and you should see a square wave of current on the oscilloscope (Figure 3). When the electrode contacts the resistance seen by the amplifier will increase, so the current will decrease. As the patch seal is formed (through suction) the current will decrease further. The better the patch seal the smaller the current waveform will be.

Figure 2. Electrode in the air

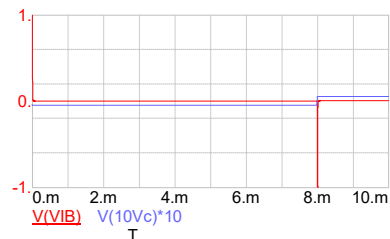

In our case we will be using the model cell to simulate these conditions. You have two choices for producing the square wave clamping signal. You can either use the built in signal by switching the **MODE** switch to **Vcomp**, or you can provide your own signal through the **EXTERNAL CLAMP SIGNAL** BNC. If you are using **Vcomp**, then the amplifier will generate a 10mV p-p 60Hz signal internally (+/- 5mV).

Figure 3. Electrode in the bath

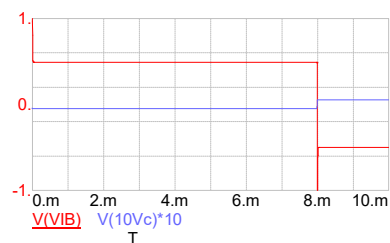

If you are using an external signal, turn the **CLAMP SIGNAL: EXTERNAL** toggle switch to  $\div 10$  or  $\div 50$  depending on the scale factor you want for your signal. If you want to use the internal signal, change **MODE** to **Vcomp**.

The signal you see on the oscilloscope should be essentially a flat line at 0VDC with sharp transients at 60Hz.

Connect a ground cable between the ground pin on the probe and the Bath pin on the model cell.

If you are using a 100Meg/10Gig Headstage Probe, the signal you see on the oscilloscope should be a 60 Hz square wave with amplitude of 10Vp-p when **PROBE: GAIN** = HIGH. Switching **PROBE: GAIN** = LOW selects the smaller feedback resistor. If that resistor value is 100Meg, then the amplitude of the square wave should be 100mVp-p. Expected observed values are listed in Table 6.

Table 6 Probe Gain and Bath VClamp

Feedback Resistor	Probe Gain	Observed Signal at OUTPUT
10Meg	10mV/nA	10mV
100Meg	100mV/nA	100mV
1Gig	1000mV/nA	1V
10Gig	10000mV/nA	10V

This signal is similar to those you would see once you have a patch electrode in a bath. Return **MODE** switch to **Vclamp**.

### Offset Zero

There can often be offsets due to different conductances between your reference electrode and your recording electrode (Figure 4). These offsets can be adjusted to zero automatically using tracking, or manually using the **OFFSET** control.

Figure 4. Offset adjustment trace

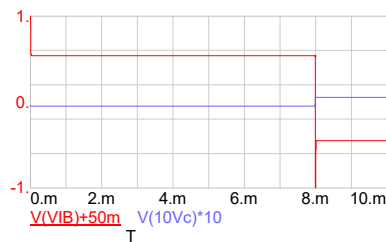

The following procedure will enable you to set the value of offset manually. First, switch the **METER** knob to **Voffset** in order to display the voltage value determined by the knob **OFFSET**. Slowly rotate **OFFSET** clockwise and watch the value on the meter increase. Set the offset value to **2mV**. Notice that as you moved **OFFSET**, the current trace on the oscilloscope did not move. This is because the offset voltage is not yet connected to the clamping potential. To turn on the offset, set the hold/offset switch to **O** for offset only (Figure 31, Page 27). Notice that the current trace is now offset vertically on the oscilloscope. We can now use this artificial offset to see how automatic tracking works.

The tracking control monitors the current output, and automatically adjusts the clamping voltage until the current equals zero. To use tracking, set the tracking switch to **TRACK**. Notice that the trace slowly adjusts until the output is centered on zero volts. To fix the offset at this value, switch the tracking knob to **SET**. This will fix the offset value and you will be able to change the clamping value again. Try adjusting **OFFSET** when the tracking switch is in the **TRACK** position and when it is in the **SET** position. If you switch the tracking switch to **OFF** this will disconnect the tracking circuit from the clamping circuit.

Return the tracking switch to **OFF** and the offset/hold switch to **OFF**. If you are using an external signal, turn the **CLAMP SIGNAL: EXTERNAL** toggle switch to  $\div 10$  or  $\div 50$  depending on the scale factor you want for your signal. If you want to use the internal signal, change the **MODE** switch to **Vcomp**.

### **CAUTION**

Make certain you ground yourself before handling the probe

## Getting A Seal

To simulate a patch seal with the model cell, change the ground connector on the model cell from **BATH** to **PATCH**. (If only it was this easy with a real cell. With a real cell you would have to monitor your approach to the cell by watching until the current pulses become about half as large. Application of suction, if applied properly (see Single-Channel Recording by Sakmann and Neher), will form a giga-seal seen by the current trace becoming essentially flat, with capacitive transients at rising and falling edges of the clamp signal).

Figure 5. Patch seal trace

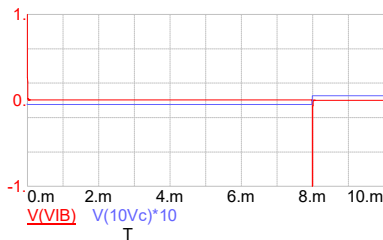
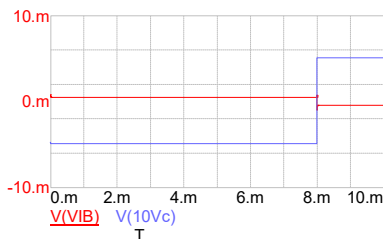

Figure 6. Patch seal with transients compensated



## Capacity Compensation

Once you have switched the model cell connection from **BATH** to **PATCH** the trace on the oscilloscope should be flat with small transients at the frequency of the clamping signal (Figure 5). These transients are due to the total capacitance of the amplifier, holder, and electrode. You should verify that **PROBE GAIN** is **HIGH** in order to see clearly the transients. These transients can be cancelled out using **CAPACITY COMPENSATION** knobs **FAST 1** and **FAST 2**. Use both the **FAST 1:GAIN** and **FAST 1:LAG** to minimize the transient. You will need to alternate between **GAIN** and **LAG** until the trace looks similar to Figure 6. While working with a real cell, you may need to use **FAST2** if there is more than one time constant to the transient.

## Filtering

You can further optimize the output signal available at **MODE OUTPUT** by using the four-pole low pass Bessel filter. This filter affects only the **MODE OUTPUT** and does not affect the **x10Vm** or **Im** outputs. To adjust the filter frequency, turn the **MODE: FILTER** knob to the desired filter frequency. Changing the **METER** knob to Noise will result in the display indicating the noise levels with the selected filter applied. When you change the **METER** knob to **MODE** the meter will display the membrane current.

## Holding and Command Signals

**CLAMP SIGNAL: HOLD** provides a holding potential to the cell. This knob works similar to **OFFSET**, except a change in the holding potential is seen as a change in both membrane voltage and current, while **OFFSET** only affects the membrane current.

Switch the **METER** knob to **Vhold**. Using **HOLD**, adjust the value to 0mV. Switch the **METER** knob to **Voffset**. Using **OFFSET**, adjust the value to 0mV. Connect a BNC cable from the **x10Vm** output to Channel 2 of your oscilloscope. Set the voltage range on channel 2 to 1V/division.

Adjust the hold/offset switch to **O**. This will turn on the **OFFSET** control. Adjust the **OFFSET** control and watch as both the value on the meter and the output change, but the x10Vm does not (oscilloscope channel 2). Switch the **METER** knob to **Vhold** and the hold/offset switch to **(H+O)**. This will turn on both the **OFFSET** and **HOLD** controls. Adjust **HOLD** and watch how the meter, **MODE OUTPUT**, and **x10Vm** output all change.

Any command potential that is not a constant DC command must be created with an external device and connected to the **EXTERNAL** input. The external input is then divided by 10 or 50 before it reaches the cell, depending on the setting of the **EXTERNAL** switch.

## Recording

Typically in channel recordings you would record both the membrane voltage and current. You can get both of these outputs from the front panel of the 2400. It is advantageous to monitor membrane current at the **MODE OUTPUT**, rather than **Im**, because **MODE OUTPUT** can be filtered using **FILTER** and amplified using **GAIN**, whereas the **Im** output is an unfiltered, un-amplified output straight from the probe. The membrane voltage is recorded from the **x10Vm** output.

Outputs can be recorded onto a computer using any number of analog to digital converters available from a variety of manufacturers. See Chapter 4 “connecting to your computer” for more information.

## Whole Cell Recordings

This section will walk you through the features of the Model 2400 that are commonly used in a typical whole cell recording experiment. In this section, we will be using the model cell, but after you become familiar with the controls you will be able to substitute a real electrode and cell for the model cell.

The model cell is an electrical equivalent circuit of a simplified electrode/bath/cell interface. Figure 1 shows the schematic diagram of the model cell. The component names indicate what part of the electrode, bath, or cell they represent.

Equipment you will need in this section is the Model 2400 with probe, the model cell, and an oscilloscope. In a real experiment, you would also need a pulse generator, a cell chamber (bath), a cell, a manipulator, and something to record your data.



## Set-Up

Set the controls on the front panel as follows:

Table 7 Whole Cell set-up

<b>METER</b> (knob)	<b>MODE</b>
<b>MODE</b>	<b>Vclamp</b>
<b>MODE: PROBE GAIN</b>	<b>LOW</b>
<b>MODE: GAIN</b>	<b>1</b>
<b>MODE: FILTER</b>	Open
<b>CAPACITY COMPENSATION: FAST1: Gain</b>	Fully counterclockwise
<b>CAPACITY COMPENSATION: FAST1: Lag</b>	Fully counterclockwise
<b>CAPACITY COMPENSATION: FAST2</b>	Fully counterclockwise (inner and outer knob)
<b>WHOLE CELL COMPENSATION</b>	<b>OFF</b>
<b>SERIES RESISTANCE</b>	<b>OFF</b>
<b>CLAMP SIGNAL</b> (Hold/Offset Toggle)	<b>OFF</b>
<b>CLAMP SIGNAL: 3kHz</b>	<b>OFF</b>
<b>CLAMP SIGNAL</b> (tracking)	<b>OFF</b>
<b>CLAMP SIGNAL: EXTERNAL</b>	<b>OFF</b>

Connect the **MODE: OUTPUT** to channel 1 on your oscilloscope. Set the oscilloscope to 1V/division, 2ms/division, and trigger on channel 1. Place the probe in your recording chamber attached to your micromanipulator. In a normal experiment, you would then attach the electrode holder and patch pipette to the BNC connector on the probe. Instead, attach the model cell to the probe's BNC connector, but leave the ground pin unconnected.

## Entering the Bath

Normally as you approach the cell you would provide a square wave voltage clamp signal (10mV, 60Hz). In theory, before you enter the bath the current resulting from the square wave is essentially zero since you are clamping an extremely large resistance (from the electrode through the air to your reference electrode) (Figure 2). Small transients at the frequency of the clamping signal might be observed. When the electrode enters the bath the resistance seen by the amplifier will suddenly drop to the resistance of the electrode. This will mean there will be a large increase in current and you should see a square wave of current on the oscilloscope (Figure 3). When the electrode contacts the cell the resistance seen by the amplifier will increase, so the current will decrease. As the patch seal is formed (through suction) the current will decrease further. The better the patch seal the smaller the current waveform will be.

In our case we will be using the model cell to simulate these conditions. You have two choices for producing the square wave clamping signal. You can either use the Model 2400's built-in signal by switching the **MODE** switch to **Vcomp**, or you can provide your own signal through the **EXTERNAL CLAMP SIGNAL** BNC.

If you are using an external signal, turn the **CLAMP SIGNAL: EXTERNAL** toggle switch to  $\div 10$  or  $\div 50$  depending on the scale factor you want for your signal. If you want to use the internal signal, change the **MODE** switch to **Vcomp**.

Turn on the model 2400.

The signal you see on the oscilloscope should be essentially a flat line at 0VDC with sharp transients at 60Hz.

Connect a ground cable between the ground pin on the probe and the Bath pin on the model cell.

If you are using a 100Meg/10Gig Headstage Probe, the signal you see on the oscilloscope should be a 60 Hz square wave with amplitude of 100mV<sub>p-p</sub> when **PROBE: GAIN** = LOW. Expected observed values are listed in Table 6.

This signal is similar to those you would see once you have a patch electrode in a bath. Return **MODE** switch to **Vclamp**.

### Offset Zero

There can often be offsets due to different conductances between your reference electrode and your recording electrode. These offsets can be adjusted to zero automatically using tracking, or manually using the **OFFSET** control.

The following procedure will enable you to set the value of offset manually. First, switch the **METER** knob to **Voffset** in order to display the voltage value determined by the knob **OFFSET**. Slowly rotate **OFFSET** clockwise and watch the value on the meter increase. Set the offset value to **50mV**. Notice that as you moved **OFFSET**, the current trace on the oscilloscope did not move. This is because the offset voltage is not yet connected to the clamping potential. To turn on the offset, set the hold/offset switch to **O** for offset only (Figure 31, Page 27). Notice that the current trace is now offset vertically on the oscilloscope. We can now use this artificial offset to see how automatic tracking works.

The tracking control monitors the current output, and automatically adjusts the clamping voltage until the current equals zero. To use tracking, set the tracking switch to **TRACK**. Notice that the trace slowly adjusts until the output is centered on zero volts. To set the offset value at this value switch the tracking knob to **SET**. This will fix the offset value and you will be able to change the clamping value again. Try adjusting **OFFSET** when the tracking switch is in the **TRACK** position and when it is in the **SET** position. If you switch the tracking switch to **OFF** this will disconnect the tracking value from the clamping circuit.

Return the tracking switch to **OFF** and the offset/hold switch to **OFF**. If you are using an external signal, turn the **CLAMP SIGNAL: EXTERNAL** toggle switch to  $\div 10$  or  $\div 50$  depending on the scale factor you want for your signal. If you want to use the internal signal, change the **MODE** switch to **Vcomp**.

## CAUTION

Make certain you ground yourself before handling the probe

**Figure 7. Whole cell recording before capacity compensation**

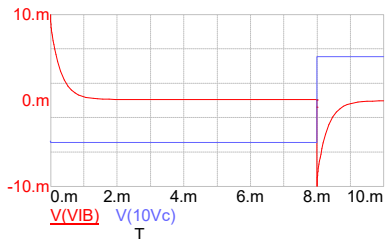

**Figure 8. Whole cell recording with fast transients cancelled**

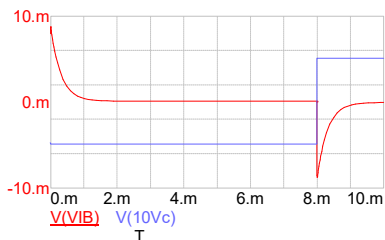

**Figure 9. Whole cell recording with all transients cancelled**

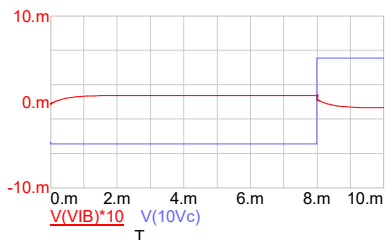

## Attaching To A Cell

To simulate a seal with the model cell you need to do is change the ground connector on the model cell from **BATH** to **PATCH**. With a real cell you would have to monitor your approach to the cell by watching until the current pulses become about half as large. Application of suction, if applied properly (see Single-Channel Recording by Sakmann and Neher), will form a giga-seal seen by the current trace becoming essentially flat, with capacitive transients at rising and falling edges of the clamp signal. After the seal is formed, access to the cell can be achieved by a number of methods, including applying more suction. In the model cell access to the cell is made by changing the connection from **PATCH** to **CELL**.

## Capacity Compensation

Once you have switched the model cell connection from **BATH** to **CELL** the trace on the oscilloscope should be a square wave with large transients at the frequency of the clamping signal (Figure 7). There are two main transients seen, a fast transient due to the capacitance of the amplifier and holder, and a slow transient due to the electrode access resistance and cell capacitance. The fast transient can be cancelled out using **CAPACITY COMPENSATION** knobs **FAST 1** and **FAST 2**. Use both the **FAST 1: GAIN** and **FAST 1: LAG** to minimize the transient. You will need to alternate between **GAIN** and **LAG** until the trace looks similar to Figure 8. While working with a real cell, you may need to use **FAST2** if there is more than one time constant to the transient.

## Whole Cell Compensation

The slow transients often seen in whole cell recording can be minimized using **WHOLE CELL COMPENSATION**. Whole cell compensation is only active when the **PROBE GAIN** is **LOW**. Confirm that **Raccess** and **Cmembrane** are fully counterclockwise. Turn on **WHOLE CELL COMPENSATION**. Alternately adjust **Raccess** and **Cmembrane** in order to reduce the slow transient. It will help as the transients get smaller to increase the voltage sensitivity on your oscilloscope (by decreasing the volts/division) to 0.5V/division. Also, if the transients are hard to eliminate, you may want to turn on the **3kHz** filter in the **CLAMP SIGNAL** section of the Model 2400. Following appropriate compensation, your trace should look like Figure 9. The values of series resistance and capacitance should match the model cell's electrode resistance and membrane capacitance respectively. Note that full scale on the **Raccess** 10-turn potentiometer is equal to 100Meg during voltage clamping.

### Series Resistance Compensation

This section will give a brief description of how to provide series resistance compensation. A more detailed description and listing of the differences between correction and prediction is given in the instrument operations chapter (Chapter 3) and circuit description chapter (Chapter 6).

If the whole cell compensation is properly tuned, you should be able to turn **RsPRE** and **RsCOMP** to 90% without producing large transients. Alternately adjusting the **LAG** control, **FAST1**, **FAST2**, and **Cmembrane** should produce a trace similar to Figure 10. A suggested step-by-step procedure follows:

**Figure 10. Whole cell recording with series resistance controls turned on to 90%**

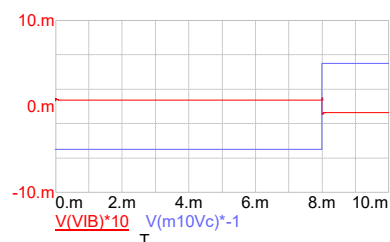

- Turn **FAST1 GAIN** counterclockwise a little bit.
- Turn **LAG<sub>fine</sub>** fully clockwise and **LAG<sub>coarse</sub>** fully counterclockwise.
- Turn **RsPRE** and **RsCOMP** fully counterclockwise.
- Turn on **SERIES RESISTANCE** (there should be no change in the waveform on Channel 1 of the oscilloscope)
- Slowly adjust **RsPRE** clockwise to 90%. Observe that no oscillations occur at the transients. If oscillations occur, adjust **RsPRE** counterclockwise.
- Adjust **FAST1-GAIN**, **FAST1-LAG**, **Raccess**, and **Cmembrane** to minimize transients.
- Slowly adjust **RsCOMP** to 90%. If necessary adjust **FAST1**, **FAST2**, and **Cmembrane** to eliminate transients.
- If transients do not minimize try turning on the **3kHz CLAMP SIGNAL** filter.

## Filtering

You can further optimize the output signal at **MODE:OUTPUT** by using the four-pole low pass Bessel filter. This filter only works on the **MODE:OUTPUT** and does not affect the **x10Vm** or **Im** outputs. To adjust the filter frequency set the **MODE: FILTER** knob to the desired value. .

The **3kHz** single pole RC filter will filter the sum total of all clamping signals. To activate this filter set the **3 kHz** switch to **ON**. This filter is useful in some whole cell experiments to smooth out the clamping signal thereby increasing the stability of series resistance compensation.

## Holding and Command Signals

**CLAMP SIGNAL: HOLD** can be used to provide a holding potential to the cell. This control works similar to **OFFSET**, except a change in the **HOLD** potential will be seen as a change in both the membrane voltage, while the **OFFSET** only affects the membrane current.

Switch the **METER** knob to **Vhold**. Using **HOLD** set the value to 0mV. Switch the **METER** knob to **Voffset**. Using **OFFSET** set the value to 0mV. Connect a BNC cable from the **x10Vm** output to channel 2 of your oscilloscope. Set the voltage range on channel 2 to 1V/division

Set the hold/offset switch to **O**. This will turn on the **OFFSET** control. Turn the **FINE OFFSET** control and watch as both the value on the meter and the output change, but the **x10Vm** does not. Switch the **METER** knob to **Vhold**. Now set the hold/offset switch to **(H+O)**. This will turn on both the **OFFSET** and **HOLD** controls. Adjust the **HOLD** knob and watch how the meter, **MODE OUTPUT**, and **x10Vm** output all change.

Any command potential that is not a constant DC command must be created with an external device connected to the **EXTERNAL** input. The external input is then divided by 10 or 50 before it reaches the cell, depending on the position of the **EXTERNAL** switch. See Pages 30 and 31 for more detail on the actual scaling factor under various modes with different headstages.

## Recording

Typically in channel recordings you would record both the membrane voltage and current. You can get both of these outputs from the front panel of the 2400. It is advantageous to monitor membrane current at the **MODE OUTPUT**, rather than **Im**, because **MODE OUTPUT** can be filtered using **FILTER** and amplified using **GAIN**, whereas the **Im** output is an unfiltered, un-amplified output straight from the probe. The membrane voltage can be recorded from the **x10Vm** output.

Outputs can be recorded onto a computer using any number of analog to digital converters available from a variety of manufacturers. See Chapter 4 “connecting to your computer” for more information.

## Current Clamp Recordings

Whenever the **MODE** knob is set to **I=0**, **Iclamp**, **Iresist**, or **Ifollow** the amplifier is in current clamp mode. In current clamp mode the model 2400 performs like any other intracellular amplifier. The probe becomes a voltage follower, the clamping signals become current injection signals, and the **WHOLE CELL COMPENSATION: Raccess** and **SERIES RESISTANCE: I Clamp** become the bridge balance controls. Since the **HOLD** and **OFFSET** commands are used in both the current clamp and voltage clamp modes, the **I=0** mode is positioned between the two modes in order for these values to be reset to appropriate current, or voltage clamp values.

## Set Up

Connect the **x10Vm OUTPUT** to channel 1 on your oscilloscope and set the amplitude to 1V/division and the time base to 1ms/division. Set the controls on the front panel as follows:

Table 8 Current clamp set-up

<b>METER</b> (knob)	<b>MODE</b>
<b>MODE</b>	<b>I=0</b>
<b>MODE: PROBE GAIN</b>	<b>LOW</b>
<b>MODE: GAIN</b>	<b>1</b>
<b>MODE: FILTER</b>	Open
<b>CAPACITY COMPENSATION: FAST1: Gain</b>	Fully counterclockwise
<b>CAPACITY COMPENSATION: FAST1: Lag</b>	Fully counterclockwise
<b>CAPACITY COMPENSATION: FAST2</b>	Fully counterclockwise (inner and outer knob)
<b>WHOLE CELL COMPENSATION</b>	<b>OFF</b>
<b>SERIES RESISTANCE</b>	<b>OFF</b>
<b>CLAMP SIGNAL</b> (Hold/Offset Toggle)	<b>OFF</b>
<b>CLAMP SIGNAL: 3kHz</b>	<b>OFF</b>
<b>CLAMP SIGNAL</b> (tracking)	<b>OFF</b>
<b>CLAMP SIGNAL: EXTERNAL</b>	<b>OFF</b>

Connect the model cell to the probe. Connect the ground wire from the ground on the probe to the BATH connector on the model cell. Turn the amplifier on.

## Offset Zero

There can often be offsets due to different conductances between your reference electrode and your recording electrode. These offsets can be adjusted to zero using tracking, or manually using the **OFFSET** control.

Set the **METER** knob to **Voffset** in order to display the value of the voltage determined by **OFFSET**. Slowly rotate **OFFSET** clockwise and watch the value on the meter increase. Set the offset value to **10mV**. Notice that as you adjust **OFFSET** the output trace on the oscilloscope does not move. This is because the offset voltage is not yet connected to the output signal. Set **METER** to **MODE**. To turn on **OFFSET**, set the hold/offset switch to **O** for offset only (Figure 31). Notice that the output trace is now offset vertically on the scope. The meter displays the offset voltage value of the model cell.

## Capacity Compensation

Switch **MODE** to **Iresist**. This will inject a 60 Hz square-wave current through the model cell. The digital display now indicates the resistance of the model cell. On channel 1 of the oscilloscope, you will see square wave with slightly rounded corners. This rounding is due to the capacitance of the amplifier and model cell. The capacitance can be compensated by adjusting **FAST1-GAIN**. Avoid over-compensation, which will cause excessive noise and high frequency oscillations.

## Bridge Balance

A bridge balance is used to remove the voltage drop due to the electrode that occurs prior to attaching the electrode to a cell. The Model 2400 Bridge Balance is controlled by the knobs and switches located in the area of diagonal lines. Turn on the bridge balance by switching the **SERIES RESISTANCE** On/Off switch (located in the lower right portion of highlighted field) to **On**. If you have just completed the whole cell compensation from the previous section then **Raccess** should be approximately the correct value. If not you will need to adjust **Raccess** until the square wave is flat except for transients at the leading and trailing edges of the square wave.

In Current Clamp mode, the maximum value of **Raccess** is 100% x the magnitude of the low feedback resistor. Thus, with a 100M / 10G headstage, the maximum value of **Raccess** during current clamp is 100M.

To eliminate the transients, first confirm that the **PEAKING** and **LAG** knobs are fully counterclockwise. Adjust **LAG** first and then **PEAKING** to minimize the transients.

## Filtering

To see the effect of filtering you will need to connect the **MODE OUTPUT** to channel 1 of the oscilloscope. The **x10Vm** output is not filtered, and the **Iresist** square wave current can only be viewed out of the **x10Vm** output. In **Iresist** mode the **MODE OUTPUT** shows a DC potential equal to the resistance of your electrode.

Set **METER** to **Noise**. The meter will now display the noise present on the signal. Turn **FILTER** counterclockwise through the positions and watch the noise value decrease.

### Holding and Command Signals

Constant holding potentials can be applied to the electrode by switching the hold/offset switch to **(H+O)** and adjusting **HOLD**. The value of current applied can be viewed on the meter by switching the **METER** knob to **Vhold**. Any time-varying signal must be applied by a separate device connected to the **EXTERNAL** input.

### Recording

Outputs can be recorded onto a computer using any number of analog to digital converters available from a variety of manufacturers. See the “connecting to your computer” chapter (Chapter 4) for more information.

### Operational Mode Summary

Table 9 lists which front control panels are active during various operational modes.

**Table 9** Probe resistor values

	Voltage Modes		Current Modes	
	Low	High	Low	High
Probe Gain Switch	Low	High	Low	High
Capacity Compensation	Yes	Yes	Yes	Yes
Whole Cell Resistance	Yes	No	Yes	No
Series Resistance	Yes	Yes	Yes	No
Bridge Balance	No	No	Yes	Yes



# 3

## Instrument Operation

The controls and connections in this section are listed as follows, the probe, the front panel from left to right, and the rear panel from left to right.

### Probe

The probe is both a current-to-voltage converter and a voltage follower. When voltage clamping, the probe can be operated in either low or high gain by remotely switching the value of the internal resistor. Below is a table of the different probes you can purchase from A-M Systems, Inc. and their feedback resistors.

Figure 11. The Probe



Table 10 Probe resistor values

Probe Catalog #	Low Probe Gain Resistor Value	High Probe Gain Resistor Value
880210	10M	1G
880218	10M	10G
880222	100M	10G

The probe has two connections: the input BNC, and a ground jack (gold pin).

The input BNC will hold any BNC style electrode holder, and is where the input signal is connected. The center conductor is connected through a current limiting resistor to a field effect transistor amplifier. Other than the current limiting resistor there is no other protection to the probe so care must be taken to avoid electrostatic discharges. The outer conductor of the BNC, and the gold pin jack are connected to signal ground, the same ground that is in the main amplifier.

The white jack is a driven shield, or guard, and is a buffered version of the input voltage, so care must be taken *not* to ground the this jack.

**Table 11 Probe Pin-out**

The probe cable terminates in a 15 pin D-sub connector for attaching to the rear panel of the instrument. The pin out is listed below.

Pin #	Wire Color	Functional Description
1	Shield	Ground and cable shield
2	NC	
3	Yellow	Current Clamp signal source
4	White	Im output
5	Grey	Whole Cell compensation signal
6	Black	-15VDC
7	Brown	Control for switching between current clamp and voltage clamp
8	Purple	Control for switching between the two feedback resistors
9	NC	
10	NC	
11	Green	Vm output
12	Red	+15VDC
13	Blue	Capacity compensation signal
14	Orange	Voltage clamping signal source
15	NC	Ground

Figure 12. Power switch

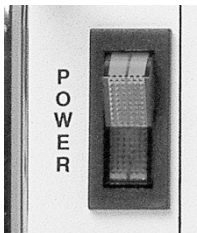

## Power

The model 2400 has an illuminated power supply switch that will light when line power is passing through it. If it does not light then there is no line power to the amplifier. Provided the **METER** is not in **Vtest**, the meter will illuminate when there is DC power to the amplifier.

Figure 13. Meter

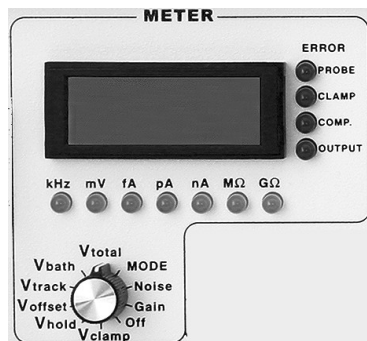

## Meter

The liquid crystal display (LCD) on the 2400 is a digital voltmeter whose input is determined by **METER** and **MODE** positions.

**Table 12 Meter Display settings**

The following table lists the inputs to the meter based on each knob position.

METER knob	MODE knob	Meter Display	METER knob	MODE knob	Meter Display
MODE	VTest	OFF	Noise	Iclamp	RMS(Filterd Vm)
MODE	Vcomp	Im	Noise	Iresist	OFF
MODE	Vclamp	Im	Noise	Ifollow	OFF
MODE	I=0	Vm	Gain	X	<b>MODE OUTPUT</b> gain
MODE	Iclamp	Vm	Vclamp	X	EXTERNAL command
MODE	Iresist	Probe input resistance	Vhold	X	HOLD command
MODE	Ifollow	Vm	Voffset	X	OFFSET potential
Noise	Vcomp	RMS(Filterd Im)	Vtrack	X	Tracking command
Noise	Vclamp	RMS(Filterd Im)	Vbath	X	Bath voltage
Noise	I=0	RMS(Filterd Vm)	Vtotal	X	Total command signal

X=knob position does not affect input.

Seven green light emitting diodes (LED) indicate units for the digital display. Four red LED's indicate overload, or error conditions of the amplifier. The **PROBE** LED will light if the Im or Vm output of the probe exceeds  $\pm 10V$ , or the probe is disconnected from the amplifier. The **CLAMP** LED will light if any of the following signals have values greater than  $\pm 10V$ : **EXTERNAL** input, **TRACK** signal, the sum of **HOLD** + **OFFSET** + bath input, and the total clamp signal. The **COMP** LED will light if the compensation signal sent to the probe exceeds  $\pm 10V$ . The **OUTPUT** LED will light if the gain in the output amplifiers exceeds  $\pm 10V$ .

### Mode

There are two main modes for the Model 2400; current clamp modes and voltage clamp modes. Voltage clamp modes on the **MODE** knob all start with V, while current clamp modes start with I. In voltage clamp modes, the signal measured is membrane current. In current clamp modes, the signal measured is membrane voltage. When set to the current clamp mode, I=0, all commands potentials are set to zero. This is a useful position to readjust command signals when switching between voltage clamp and current clamp.

### Probe Gain

Figure 14. Mode



Figure 15. Probe Gain

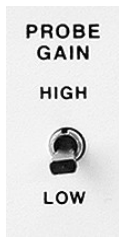

In Voltage Clamp modes, this switch selects which feedback resistor in the probe is utilized. The **HIGH** position selects the feedback resistor with the larger resistance value. For example, if the two feedback resistors are 100M and 10G then putting the **PROBE GAIN** switch in the **HIGH** position will select the 10G resistor, while the **LOW** position will select the 100M resistor.

Table 13 lists the gains of the probe in Voltage clamp mode depending on the feedback resistor.

**Table 13** Probe resistor current gain

Feedback Resistor	Probe Gain
10M	10mV/nA
100M	100mV/nA
1G	1mV/pA
10G	10mV/pA

In Current Clamp Mode, **PROBE GAIN** sets the scaling for the **EXTERNAL** clamp signal in and **HOLD**. When set to HIGH, the current clamp circuitry is more sensitive. Critical values for External Clamp Scaling for Voltage and Current Clamp modes are listed in Table 15.

**Figure 16.** Filter



### Filter

This 7-position switch is used to set the 3dB cut-off frequency for the 4-pole Bessel filter. Only **MODE:OUTPUT** BNC signals are filtered. When in the **Open** position, the filter is bypassed.

**Figure 17.** Gain

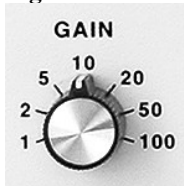

### Gain

After signals pass through the Bessel filter, they are processed by an internal gain amplifier before being sent to the **MODE:OUTPUT** BNC. The gain of this amplifier is set with the **GAIN** knob. This gain is in addition to the gain of the feedback resistor in the probe. For example, if the feedback resistor is 1G and the **GAIN** knob is set to 20, the current gain on the **OUTPUT BNC** will be:

$$1\text{mV/pA} * 20 = 20\text{mV/pA}.$$

**Figure 18.** Mode Output



## Output

The **MODE:OUTPUT** BNC provides a filtered and amplified version of the raw probe signal. The output will change depending on the position of the **MODE** switch. The following table lists the conditioned probe signals for the corresponding **MODE** switch position.

Table 14 Mode output units

VTest	Im
Vcomp	Im
Vclamp	Im
I=0	Vm
Iclamp	Vm
Iresist	1mV/MΩ
Ifollow	Vm

Figure 19. Capacity Compensation

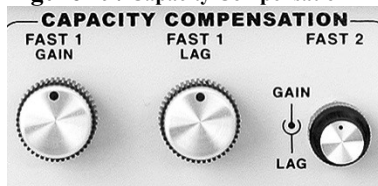

## Capacity Compensation

**FAST1** and **FAST2** provide compensation for electrode and holder capacitances by providing a separate path for charging these capacitances during signal changes. The **FAST1** and **FAST2** controls provide two separate time constants for amplifier-cell transients that cannot be modeled by a single time constant. Most transients caused by the electrode and holder can be compensated with just the **FAST1** controls, however some experiments will need to use **FAST2**. The time constants can be set by adjusting the **LAG** controls of **FAST 1** and **FAST 2**, while the percentage of compensation can be adjusted by the **GAIN** controls.

Figure 20. Fixed outputs



## Fixed Outputs

Unfiltered Im and x10Vm signals from the probe are available at these two BNC's. Adjusting the **FILTER**, **GAIN**, or **MODE** knob will not affect these outputs. However, in voltage clamp modes the **PROBE GAIN** will affect the gain of the Im output (see the Probe gain section for Im probe gains).



**Figure 21. Whole Cell Compensation**

## Whole Cell Compensation

Whole cell compensation is used to compensate for the large capacitances seen in whole cell voltage clamp recordings. **Raccess** and **Cmembrane** are calibrated knobs that indicate the values of access resistance and cell membrane capacitance respectively. For patch electrodes, the access resistance is the resistance of the electrode and hole providing access to the cell's interior. For sharp electrodes, access resistance is just the resistance of the electrode.

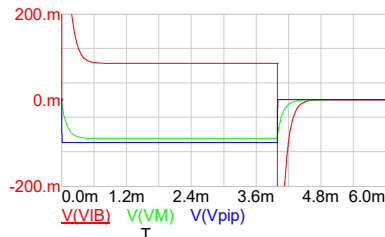

**Figure 22. Whole cell recording before compensation**

The effects of compensation controls can be seen in Figure 22 through Figure 29. All figures use the solid (red) trace for the measured  $I_m$  ( $V_{vib}$ ), dashed (green) trace for the actual  $V_m$  ( $V_m$ , measured at the top of  $R_m$  in the model cell), and dotted (blue) lines for the clamping signal seen at the pipette ( $V_{pip}$ ). Values for the model cell used in these recordings are:  $R_m=100M$ ,  $R_{electrode}=10M$ ,  $C_m=10pF$ ,  $C_{electrode}=1pF$ .

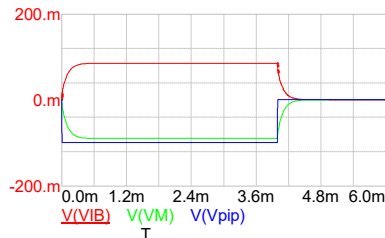

**Figure 23. Whole cell recording after whole cell compensation**

In voltage clamp modes, whole cell compensation is used to eliminate the transients caused by the access resistance of the electrode and the membrane capacitance. An uncompensated signal right after attaching to a whole cell is shown in Figure 22. By alternately adjusting **Raccess** clockwise a small amount and then **Cmembrane** clockwise a small amount you should be able to minimize these transients as seen in Figure 23.

If you do not get a response like that in Figure 23, then re-adjust **FAST1** or turn on the 3 kHz clamping filter. When all else fails the output filter can be reduced to lessen the transients; however reducing the filter cut-off frequency while there are still large transients will make series resistance compensation much harder.

In current clamp modes, **Raccess** is part of the bridge balance (See Current Clamp on Page 27).

This function is disabled when **WHOLE CELL COMPENSATION** is disabled when the **WHOLE CELL COMPENSATION** switch is in the **OFF** position. Note that when in current clamp modes **Cmembrane** is inoperative.



**Figure 24. Series Resistance controls**

## Series Resistance

Series resistance is typically used in whole cell recordings to compensate for the time constant and voltage drop caused by the access resistance and cell membrane capacitance.

Series resistance has two sections, compensation for voltage clamping and compensation used in current clamping. The **LAGfine**, **LAGcoarse**, **RsPRE**, and **RsCOMP** are only used in voltage clamp modes. The **PEAKING** and **LAG** controls are only used in current clamp modes. As a group, these controls are turned on or off by **SERIES RESISTANCE:ON-OFF**.

**Figure 25. Voltage clamp series resistance controls**



## Voltage Clamp

When the Model 2400 is in a voltage clamp mode, the **VOLTAGE CLAMP** section of **SERIES RESISTANCE** will be activated.

The **LAGfine** and **LAGcoarse** work together with **RsCOMP** to provide positive feedback of the membrane current to the clamping signal. Because positive feedback is inherently unstable it is important to use these controls carefully to prevent undesired oscillations in the recording. **RsPRE** instead provides a predictive signal to the clamping signal based on values set in the **WHOLE CELL COMPENSATION** section. Because the predictive signal does not utilize positive feedback, it is not inherently unstable, but if the whole cell parameters are not properly tuned, damped oscillations may occur.

After clamping on a cell and gaining access to the inside, the typical response is illustrated in Figure 22. As shown,  $V_m$  is not clamped to the same level as desired ( $V_{pip}$ ). This is due to the voltage drop across the electrode. Also notice the time response of  $V_m$  is slower than the desired clamping signal.

The transients in  $I_m$  can be compensated using the **WHOLE CELL COMPENSATION** section described above. A properly compensated system is shown in Figure 26. Notice now the time-constant of  $I_m$  is the same as the true membrane voltage.

**Figure 26. Whole cell recordings with RsPre at 90%**

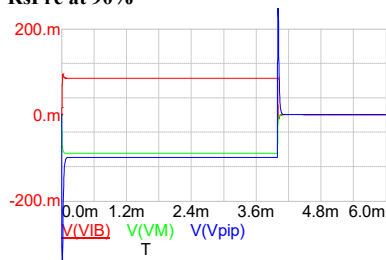

If just  $R_sPre$  is turned on to 90%, you get the response shown in Figure 26. The predictive compensation can be used to compensate for most of the lag in the desired membrane voltage. If just  $R_sPre$  is used then the only error in the true membrane voltage will be due to the voltage drop across the electrode. If the access resistance is less than 10 times smaller than the membrane resistance then you will have less than 10% error in your desired clamping voltage. For this reason it is good to try and keep the electrode-cell interface as clean as possible.

**Figure 27. Whole cell recordings with RsComp at 90%**

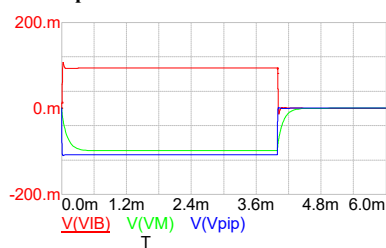

If you cannot keep the access resistance much smaller than the membrane resistance than you will need to use  $R_sComp$ . Figure 27 illustrates what the recording will look like if  $R_sComp$ , but not  $R_sPre$  is turned to 90%.  $R_sComp$  will compensate for the drop across the electrode by boosting the clamping signal through positive feedback. If the clamping signal is increased past the desired clamping level the clamp signal will become unstable and oscillations will occur. You can see the beginnings of these oscillations when  $R_sComp$  is turned past 90% (Figure 27). Notice now that the true membrane voltage is almost exactly at the desired  $-100mV$ , while the clamping signal has changed to  $-110mV$  to compensate for the voltage drop across the electrode. Also notice that not all of the lag in the true membrane voltage has been compensated for.

**Figure 28. Whole cell recording with RsComp and RsPre at 90%**

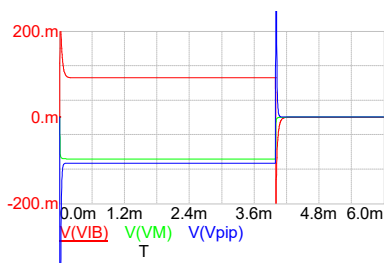

**Figure 29.** Whole cell recording with RsComp and RsPre at 90% and Whole Cell parameters readjusted

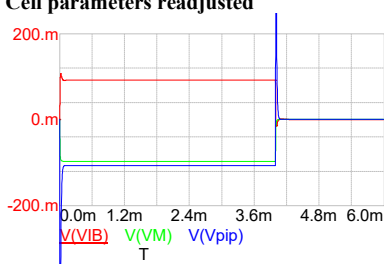

**Figure 30.** Current clamp Bridge Balance



**Figure 31.** Hold and Offset command control



This is because time constant effects are logarithmic in effect, while the voltage drop is linear. So in order to eliminate most of the lag effects you would need to set RsComp very close to 100%. Since this normally causes instability, it is best to use RsComp together with RsPre.

Figure 28 illustrates the response when both RsPre and RsComp are turned to 90%. Now the true membrane voltage is almost exactly the desired clamping signal in both amplitude and time response. After these adjustments are made there are often small transients left from slightly misadjusted controls in the **WHOLE CELL COMPENSATION** section. In order to get rid of these transients you will need to re-adjust **Raccess**, **Cmembrane**, and possibly **FAST1**. After these are adjusted you should get a response similar to Figure 29.

## Current Clamp

When the Model 2400 is in a current clamp mode, then the bridge balance is controlled by **WHOLE CELL COMPENSATION: Raccess** and **SERIES RESISTANCE: CURRENT CLAMP**, as indicated by the highlighted area of diagonal lines (Figure 30). Adjustment of these controls should eliminate any transients due to **Raccess** until the square wave is flat except for transients at the leading and trailing edges of the square wave. These two controls are for eliminating the transients that sometimes occur when trying to compensate for the voltage drop due to the electrode that occurs prior to attaching the electrode to a cell. **PEAKING** will sharpen the transient peaks, while **LAG** will smooth them out. Alternately adjusting the two knobs will mostly eliminate the transients, in conjunction with **Raccess**. It is often best to start with **LAG** first and then use **TRANSIENT**.

In Current Clamp mode, the maximum value of **Raccess** is 100% x the magnitude of the low feedback resistor. Thus, with a 100M / 10G headstage, the maximum value of **Raccess** during current clamp is 100M.

## Clamp Signal

The **CLAMP SIGNAL** section includes five separate controls for producing command signals.

### Hold

The **HOLD** control is a dual single turn potentiometer providing a constant DC command potential from -200mV to +200mV. The center knob provides fine control of  $\pm 20\text{mV}$  centered on the value of the outer knob that ranges from  $\pm 185\text{mV}$ .



In order for the **HOLD** command to be active the Hold/Offset toggle switch (Figure 31) must be set to **(H+O)**. The exact command value can be viewed on the meter display before or during activation of the hold command by setting the **METER** knob to **Vhold**.

### Offset

The **OFFSET** control is a dual single turn potentiometer providing a constant DC command potential from  $-100\text{mV}$  to  $+100\text{mV}$ . The center knob provides fine control of  $\pm 10\text{mV}$  centered on the value of the outer knob that ranges from  $\pm 95\text{mV}$ .

In order for the **OFFSET** command to be active the Hold/Offset toggle switch must be set to **(O)**, or **(H+O)**. The exact command value can be viewed on the meter display before or during activation of the offset command by setting the **METER** knob to **Voffset**.

### Track

The tracking control monitors the current output, and automatically adjusts the clamping voltage until the current equals zero. To use tracking set the tracking switch to **TRACK**. Once the desired output has been achieved the value of tracking can be fixed by moving the tracking knob to **SET**. Returning the tracking switch to **OFF** will reset the tracking value that was stored in the **SET** position to zero volts and turn off the tracking signal.

Figure 32. Tracking Controls

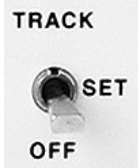

Figure 33. Command Filter



### 3kHz Filter

The **3 kHz** toggle switch activates a 2-pole low pass Bessel filter with a cut-off frequency of 3 kHz in the total command signal pathway.

### External

An external command signal can be added to the internally operates command signals by connecting a signal source to the **EXTERNAL** input BNC. During Voltage Clamping, the external BNC input is controlled by the External toggle switch. With the toggle switch in the OFF position, all signals to the **EXTERNAL** input BNC are ignored. With the switch in the  $\div 50$  position any input signal is divided by 50 before it is sent as a clamping voltage to the cell. With the switch in the  $\div 10$  position any input signal is divided by 10 before it is sent as a clamping voltage to the cell. During Current Clamp, the scaling is determined by the **PROBE GAIN** switch and the External toggle switch. Table 15 lists actual scaling factors for all headstages in all modes.

Figure 34. External Command input

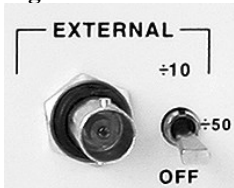

**Table 15 External Clamp Signal Scaling**

	External Clamp Switch	Voltage Clamp Modes (mV)		Current Clamp Modes (nA) Rf=value of the lower value feedback resistor	
		Probe Gain: Low	Probe Gain: High	Probe Gain: Low	Probe Gain: High
For 10M, 100M, 1GIG, and 10Gig Feedback Resistors	/10	$V_{ext}/10$	$V_{ext}/10$	$V_{ext} / (10 * R_f)$	$V_{ext} / (100 * R_f)$
	/50	$V_{ext}/50$	$V_{ext}/50$	$V_{ext} / (50 * R_f)$	$V_{ext} / (500 * R_f)$

**Figure 35. Probe input**



### **Probe Input**

The probe input is a 15 pin high density connector, used to provide power and signals to the probe. See the probe section on page 20 for a complete description of the pin assignments. The probe must be connected to the probe input for the Model 2400 to function properly. Be certain to fully tighten the screws on the probe cable to securely fasten the probe connector to the probe input.

### **Bandwidth**

The overall current bandwidth of the Model 2400 can be adjusted by this rear panel connection. Model 2400's are shipped with a default bandwidth setting of 20kHz. Using a screwdriver, the frequency can be adjusted from 10kHz to 100kHz. Some high gain probes have bandwidths below 100kHz making the probe the limiting factor and not the **BANDWIDTH** adjustment. For a list of the minimum guaranteed bandwidth for each feedback resistor see the specifications on Page 39.

**Figure 36. Bath Input**



## Bath Input

If the desired reference point for recordings is the bath rather than system ground, than a bath probe can be used and connected to the bath input. The bath probe should have a unity gain and low bandwidth (< 1kHz). Contact A-M Systems for the Bath Input connection diagram.

Figure 37. Telegraph Outputs



## Telegraph Outputs

Telegraph outputs provide voltages that correspond to amplifier settings. Voltages and there corresponding meanings are listed in the following tables.

### Cmembrane

The telegraph output for Cmembrane is 100pF/10V, so 1V would mean Cmembrane is 10pF.

Table 16 Noise telegraph output

### Noise

Probe Feedback Resistor	NOISE Output
10M	1mV/pA rms noise
100M	10mV/pA rms noise
1G	100mV/pA rms noise
10G	1mV/fA rms noise

Table 17 Gain telegraph output

### Gain

Current gain in Voltage clamp modes	Voltage Gain in Current clamp modes	GAIN Output
0.01 mV/pA	NA	0
0.02 mV/pA	NA	0.3
0.05 mV/pA	NA	0.8
0.1 mV/pA	NA	1.3
0.2 mV/pA	NA	1.8
0.5 mV/pA	NA	2.3

1 mV/pA	1 mV/mV	2.8
2 mV/pA	2 mV/mV	3.3
5 mV/pA	5 mV/mV	3.8
10 mV/pA	10 mV/mV	4.3
20 mV/pA	20 mV/mV	4.8
50 mV/pA	50 mV/mV	5.3
100 mV/pA	100 mV/mV	5.8
200 mV/pA	NA	6.3
500 mV/pA	NA	6.8
1000 mV/pA	NA	7.3
2000 mV/pA	NA	8.3
5000 mV/pA	NA	8.8

**Table 18** Filter telegraph output

### Freq

The telegraph frequency output for the four pole Bessel filter is 100mV/kHz, so 4V would mean the Bessel filter has a 3dB corner frequency of 5kHz.

Filter Frequency	Telegraph Voltage
0.5 kHz	0V
1.0 kHz	1.25V
2.0 kHz	2.5V
5.0 kHz	3.75V
10.0 kHz	5V
20.0 kHz	6.25V
Open	7.25V

**Table 19** Mode telegraph output

### Mode

Mode	MODE Output
Vtest	0V
Vcomp	0.8V
Vclamp	1.8V
I=0	2.8V
Iclamp	3.8V

Iresist	4.8V
Ifollow	5.8V

**Table 20** Error telegraph output

## Error

Overload Error Condition	Error output
True	2.5V
False	0V

**Figure 38.** AC Power Input

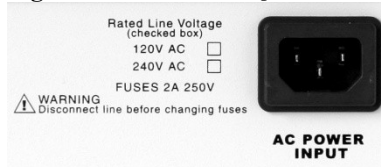

## AC Power Input

This instrument is provided with a terminal for protective grounding. Before applying power, verify that the correct safety precautions are taken. In addition, note the external markings on the instrument that indicate line voltages. Do not operate the instrument with its covers removed. Replace fuse only with specified type.

This equipment is customized at the factory for line voltages of the country of destination. The required line voltage is indicated on the rear panel (see Figure 38). Do not attach a line voltage that does not match the line voltage indicated on the rear panel. Before turning on the instrument, you must connect the protective earth terminal of the instrument to the protective earth conductor of the (mains) power cord. The mains plug must only be inserted in a socket outlet with a protective earth contact.

**Figure 39.** Model Cell



## Model Cell

The model cell is used for testing and learning how to use the Model 2400 patch clamp amplifier. The schematic for the model cell is shown in Figure 1 with each component labeled for what part of an experimental setup it represents.

Figure 39 shows the connections for the model cell. To complete the circuit the BNC connector should be connected to the input of the probe, and one of the 1mm pin connectors connected to the GND input on the probe. Switching the GND connector from one of the 1mm pin connectors to another one on the model cell will determine the model to be used.

# 4

## Connecting to a Computer

The Model 2400 has been designed with many features that allow it to be used with several different types of computer interfaces

The scaled and fixed outputs can be connected to the A/D converter inputs while the D/A output is connected to the **EXTERNAL** input. The settings of switches that specify gain, filter frequency, etc. can be measured by connecting the telegraph outputs to your A/D system. This information then can be included with your data records so that analysis programs can read it and provide accurate units information.

# 5 Troubleshooting

If the Model 2400 does not function properly, consult the following list that suggests solutions to the most common problems. If you need further assistance, please contact customer service at A-M Systems, Inc.

**Table 21** Common Problems

---

<b>Problem</b>	<b>Cause/Solution</b>
Error Lights	The corresponding function is at saturation.
Probe	The output of the probe is saturated. Make sure the Probe input is securely connected.
Clamp	The clamp signal is saturated. Make sure any external input is not above 10V given the dividing position the external switch is set to.
Comp.	The compensation is saturated. Try turning down <b>FAST1</b> or <b>FAST2</b> , turn off <b>WHOLE CELL COMPENSATION</b> , or <b>SERIES RESISTANCE</b> .
Output	The output is at saturation. Try turning down the <b>GAIN</b> .
The output never changes	Make sure the Probe input is securely connected. Verify there is a connection through the electrode to the cell.
Too much noise	Make sure the electrode holder is securely attached to the probe. Try shielding the recording chamber.

---

**Figure 40. Model 2400 Block Diagram**



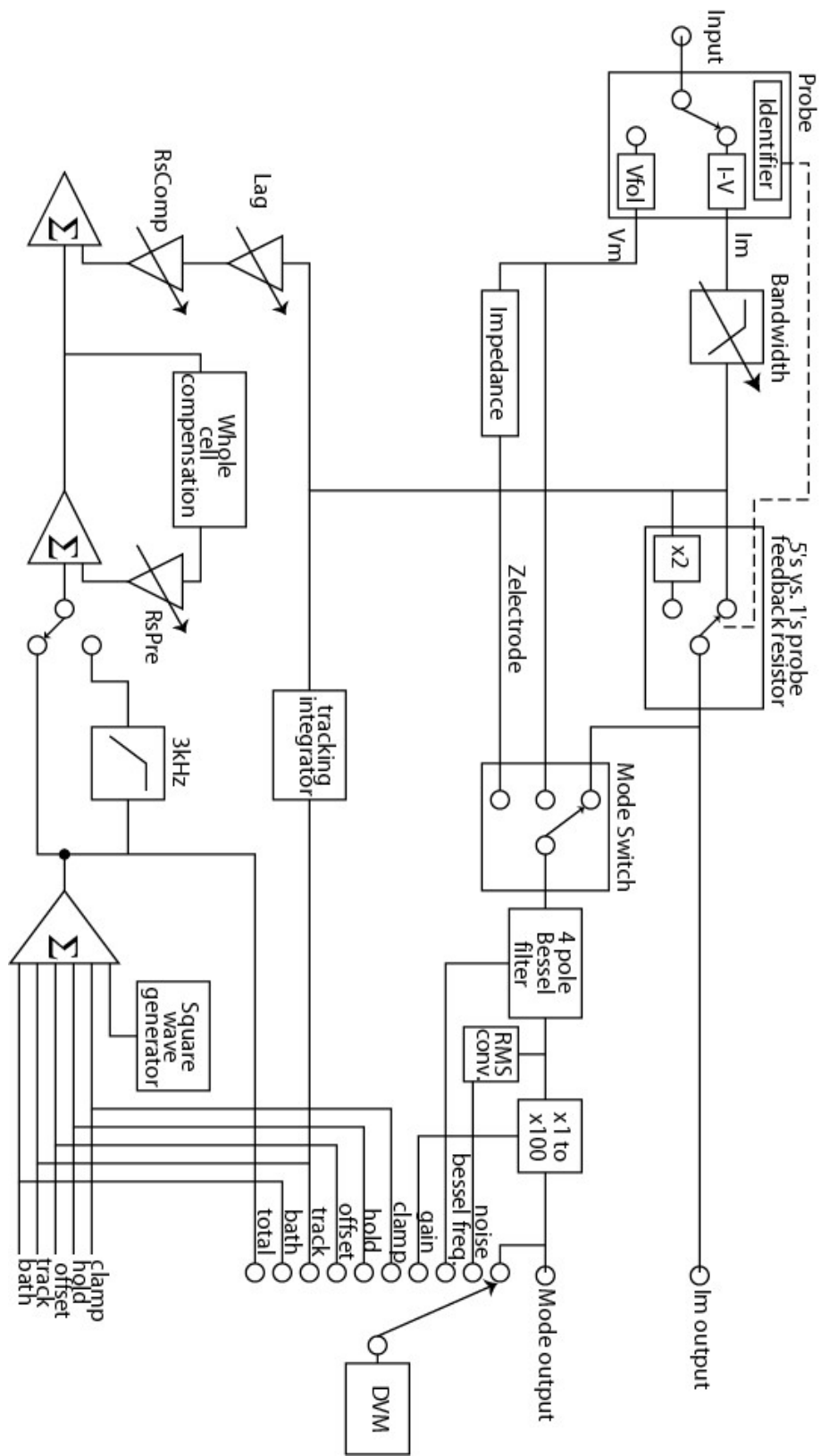

# 6

## Circuit Description

The principles of operation of the Model 2400 are described in the following section. A full schematic package can be purchased from A-M Systems, Inc. after registering your patch clamp amplifier online at: <http://www.a-msystems.com>.

Figure 40 is a block diagram of the Model 2400 illustrating how each of the following sections are connected and function together as a unit. All switching between modes and telegraph outputs are controlled by a field programmable gate array (FPGA)

### Probe

The probe contains both a current to voltage (I-V) converter and a voltage follower. A current to voltage converter has an output voltage proportional to the input current. The voltage follower has an output voltage equal to the input voltage. The block diagram of the Probe is illustrated in Figure 41.

The FPGA controls whether the probe is a follower or an I-V converter, by determining if the mode is voltage clamp or current clamp respectively. When in current clamp mode, the particular feedback resistor is determined by the **PROBE GAIN** switch on the front panel. Because of stray capacitance in the feedback resistor, the output of the I-V converter ends up low pass filtered. A frequency boost circuit in the probe removes the effects of this low pass filter before sending its output to the main amplifier.

The voltage clamp signal is divided by 10 at the probe to minimize noise effects of the clamping signal.

### Clamp Signal

In voltage clamp mode the clamp signal output goes to the voltage clamping circuit within compensation. In current clamp modes the clamp signal is sent to the current clamping circuit.

The clamp signal sums any or all of the following signals: An internal generated 100mV, 60Hz square wave, the bath voltage, the offset potential, the holding potential, the tracking signal, and the scaled external clamping signal.

The clamping signal is conditionally filtered by a 3 kHz, which is then summed with the RsPre and RsComp signals. A short lag is added to the signal before being sent to the probe in order to make capacitive compensation easier.

### Current Clamp

Together with the voltage follower in the probe, the current clamp command circuit forms a modified Howland current source in order to fix the current in the pipette to a value proportional to the clamping signal.

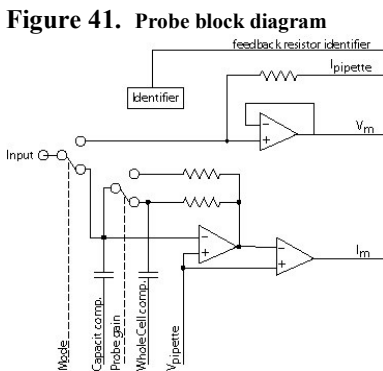

Figure 41. Probe block diagram

## **Membrane Voltage Output**

In voltage clamp mode the membrane voltage output is the clamping signal less the offset command and bath voltages. In current clamp modes, the output is the membrane voltage from the probe less the offset command, bath voltage, and bridge balance signals. The bridge balance signal is a scaled version of the clamping signal, scaled by **Raccess**.

## **Compensation**

There are three forms of compensation in the patch clamp amplifier: capacity compensation, whole cell compensation, and series resistance compensation.

In voltage clamp mode, capacity compensation takes a scaled and phase-shifted version of the clamping signal and sends it to the probe input through a capacitor, this compensates for input and pipette capacitance. In current clamp mode a scaled version of the voltage follower signal is sent to the capacitor for capacity compensation.

Whole cell compensation is only used in voltage clamp modes when the **PROBE GAIN** is set to **LOW**, and takes a transformed version of the command signal and sends it to an input capacitor in the probe. The transfer function in this section is based on the access resistance and the membrane capacitance. This transformed signal does not affect the time constant for charging the membrane capacitance (Figure 23), but transfers the burden of charging the membrane from the feedback resistor to the input capacitor. In essence, this takes the transients seen in the output of the I-V converter and puts them on the input capacitor.

Series resistance compensation is only used in voltage clamp mode and is done in two parts, one predictive and the other through positive feedback. The predictive section takes a transient signal calculated from the whole cell compensation signal and adds it to the command signal. This signal decreases the time it takes to charge the membrane capacitance. Without this signal, the membrane voltage would greatly lag the command signal (Figure 23). The positive feedback section, also called correction, takes a scaled version of the output from the I-V converter and adds it to the clamping signal. This signal compensates for the voltage drop across the electrode. Without this signal the membrane voltage would be less than the command signal (Figure 23).

Transient compensation in current clamp mode takes the scaled clamping signal used for bridge balance and decreases the response time using peaking, and increases the response time using lag, in order to match the phase from the probes voltage follower.

## Specifications

### ***Input Impedance***

Probe approximately 300 $\Omega$  in voltage clamp modes, >10<sup>12</sup> in current clamp modes  
External 17k $\Omega$

### ***Output Impedance***

All front panel outputs 50 $\Omega$   
All rear panel outputs 200 $\Omega$

### ***Input Current/Voltage ratings***

Probe Feedback Resistor	Maximum Input Voltage		Maximum Input Current	
	Voltage Clamp Modes	Current Clamp Modes	Voltage Clamp Modes	Current Clamp Modes
10M	$\pm 4V$	$\pm 12V$	1 $\mu A$	30mA
100M	$\pm 4V$	$\pm 12V$	100nA	30mA
1G	$\pm 4V$	$\pm 12V$	10nA	30mA
10G	$\pm 4V$	$\pm 12V$	1nA	30mA

### ***Probe Gain and Bandwidth***

Bandwidth in current clamp modes is 100kHz. Voltage clamp ranges are used in the following table.

Feedback Resistor	Probe Gain	Minimum Bandwidth
10M	10mV/nA	100kHz
100M	100mV/nA	100kHz
1G	1mV/pA	60kHz
10G	10mV/pA	20kHz

### ***Probe Case***

3.4" (85mm) long x 0.8" (20mm) high x 0.8" (20mm) wide

BNC input connector

1mm ground pin connector

## Maximum Instrument Noise

Voltage clamp modes measured with the internal 4 pole Bessel filter and minimum external noise.

Bandwidth	10M	100M	1G	10G
1kHz Theoretical limit	0.002 nA	0.4 pA	0.1 pA	0.04 pA
1kHz	0.003 nA	0.5 pA	0.17 pA	0.08 pA

Current clamp modes have noise levels less than 20 $\mu$ V with inputs shorted.

## Internal Bandwidth

For voltage clamping only, the bandwidth can be set from 10kHz to 100kHz.

## Membrane Current Output Range

Probe Feedback Resistor	Output range
10M	10mV/nA-1V/nA
100M	100mV/nA-10V/nA
1G	1mV/pA-100nV/pA
10G	10mV/pA-1V/pA

## Membrane Voltage Output Range

10mV/mV to 1V/mV

## Filter

4 pole Bessel filter with 6 preset values (0.5, 1.0, 2.0, 5.0, 10.0, and 20.0kHz, with 0.2kHz resolution, and an Open or Bypass position

## RMS Meter

0 to 2V<sub>rms</sub>  $\pm$ 3%

## Capacity Compensation

Voltage clamp:

FAST1: 0-10pF, 0.2-2 $\mu$ s

FAST2: 0-10pF, 0.05-1ms

Current clamp

FAST1: 0-10pF

No FAST2

## **Whole Cell Compensation**

Raccess: 0-100M $\Omega$

Cmembrane: 0-100pF

## **Series Resistance**

RsPre: 0-100%

RsComp: 0-100%

LagCoarse: 1-100 $\mu$ s

LagFine: 1-10 $\mu$ s

## **DC Balance**

Up to the-value of the low feedback resistor in the probe

## **Hold Command**

Voltage clamp:  $\pm 200$ mV

Current clamp: When PROBE GAIN is HIGH, maximum value is  $2/(100 * RfLow)$

When PROBE GAIN is LOW, maximum value is  $2/(10 * RfLow)$  .

## **Offset Command**

Voltage clamp:  $\pm 100$ mV

Current clamp:  $\pm 100$ mV (note a positive command offset will be negative on the output).

## **Speed Test Command**

Used in voltage clamp only.

0.2nA p-p at 60Hz in High Probe Gain

4nA p-p at 60Hz in Low Probe Gain

## **Vcomp Command**

$\pm 5$ mV at 60Hz

## **Iresist Command**

$\pm 1$ nA at 60Hz

## External Command: Voltage Clamp

For all headstages:

100mV/V with the external clamp set to /10, for a range of 1V

20mV/V with the external clamp set to /50, for a range of 200mV.

## External Command: Current Clamp

	External Switch	Probe Gain: Low	Probe Gain: High
For 10M, 100M, 1Gig, and 10Gig Feedback Resistors	/10	$V_{ext} / (10 * \text{Feedback Resistor})$	$V_{ext} / (100 * \text{Feedback Resistor})$
	/50	$V_{ext} / (50 * \text{Feedback Resistor})$	$V_{ext} / (500 * \text{Feedback Resistor})$

### Product 880210 10Meg / 1 Gig

hs resistor (meg)	10	10	10	10
external clamp switch	/10	/10	/50	/50
probe gain switch	LOW	HIGH	LOW	HIGH
Ext Clamp Scaling (nA / V)	10	1	2	02
Ext Max Clamp Current (nA)	100	10	20	2

### Product 880218 10Meg / 10 Gig

hs resistor (meg)	10	10	10	10
external clamp switch	/10	/10	/50	/50
probe gain switch	LOW	HIGH	LOW	HIGH
Ext Clamp Scaling (nA / V)	10	1	2	0.2
Ext Max Clamp Current (nA)	100	100	20	2

### Product 880222 100Meg / 10 Gig

hs resistor (meg)	100	100	100	100
external clamp switch	/10	/10	/50	/50
probe gain switch	LOW	HIGH	LOW	HIGH
Ext Clamp Scaling (nA / V)	1	0.1	0.2	0.02
Ext Max Clamp Current (nA)	10	1	2	0.2

## Power Supply Requirements

Line frequency and Voltage as indicated on the rear panel, either:

120V at 60Hz, or 240V at 50Hz

Fuse: 2A 250V slow-blow 5x20mm

## ***Physical Dimensions***

17”(43.2cm) x 4.75”(12.1cm) x 11.25”(28.6cm)

Weight: 22 lbs.

## ***Powered Probe Input***

---

Pin #	Functional Description
1	+15V @100mA
2	
3	Bath input
4	Ground
5	Ground
6	
7	
8	-15V @100mA

---



# Warranty

## LIMITED WARRANTY

### **What does this warranty cover?**

A-M Systems, LLC (hereinafter, “A-M Systems”) warrants to the Purchaser that the Instruments manufactured by A-M Systems (hereinafter the “hardware”), and sold after June 1, 2025, is free from defects in workmanship or material under normal use and service for 5 years from date of purchase. Headstages manufactured by A-M Systems and sold after June 1, 2025, will be repaired under warranty only once per year. This warranty commences on the date of delivery of the hardware to the Purchaser.

For hardware sold prior to June 1, 2025, the warranty in effect at time of purchase applies.

### **What are the obligations of A-M Systems under this warranty?**

During the warranty period, A-M Systems agrees to repair or replace, at its sole option, without charge to the Purchaser, any defective component part of the hardware provided that the defective part can be purchased from mainstream, common, electronic component distributors such as Digi-Key Electronics, Newark, or Mouser Electronics. To obtain warranty service, the Purchaser must return the hardware to A-M Systems or an authorized A-M Systems distributor in an adequate shipping container. Any postage, shipping and insurance charges incurred in shipping the hardware to A-M Systems must be prepaid by the Purchaser, and all risk for the hardware shall remain with Purchaser until A-M Systems takes receipt of the hardware. Upon receipt, A-M Systems will promptly repair or replace the defective unit and then return the hardware (or its replacement) to the Purchaser with postage, shipping, and insurance prepaid by the Purchaser. A-M Systems may use reconditioned or like-new parts or units at its sole option, when repairing any hardware. Repaired products shall carry the same amount of outstanding warranty as from original purchase. Any claim under the warranty must include a dated proof of purchase of the hardware covered by this warranty. In any event, A-M Systems liability for defective hardware is limited to repairing or replacing the hardware.

### **What is not covered by this warranty?**

This warranty is contingent upon proper use and maintenance of the hardware by the Purchaser and does not cover batteries. Neglect, misuse whether intentional or otherwise, tampering with or altering the hardware, damage caused by accident, damage caused by unusual physical, electrical, chemical, or electromechanical stress, damage caused by failure of electrical power, or damage caused during transportation are not covered by this warranty. Further, no guarantee is made regarding software compatibility with future updated operating systems. Products may not be returned to A-M Systems for service, whether under warranty or otherwise, which are contaminated by

infectious agents, radioactive compounds or other materials constituting a health hazard to employees of A-M Systems

**What are the limits of liability for A-M Systems under this warranty?**

A-M Systems shall not be liable for loss of data, lost profits or savings, or any special, incidental, consequential, indirect or other similar damages, whether arising from breach of contract, negligence, or other legal action, even if the company or its agent has been advised of the possibility of such damages, or for any claim brought against you by another party.

THIS EQUIPMENT IS NOT INTENDED FOR CLINICAL MEASUREMENTS USING HUMAN SUBJECTS. A-M SYSTEMS DOES NOT ASSUME RESPONSIBILITY FOR INJURY OR DAMAGE DUE TO MISUSE OF THIS EQUIPMENT.

Jurisdictions vary with regard to the enforceability of provisions excluding or limiting liability for incidental or consequential damages. Check the provision of your local jurisdiction to find out whether the above exclusion applies to you.

This warranty allocates risks of product failure between the Purchaser and A-M Systems. A-M Systems hardware pricing reflects this allocation of risk and the limitations of liability contained in this warranty. The agents, employees, distributors, and dealers of A-M Systems are not authorized to make modifications to this warranty, or additional warranties binding on the company. Accordingly, additional statements such as dealer advertising or presentations, whether oral or written, do not constitute warranties by A-M Systems and should not be relied upon. This warranty gives you specific legal rights. You may also have other rights which vary from one jurisdiction to another.

THE WARRANTY AND REMEDY PROVIDED ABOVE IS IN LIEU OF ALL OTHER WARRANTIES AND REMEDIES, WHETHER EXPRESS OR IMPLIED. A-M SYSTEMS DISCLAIMS THE WARRANTIES OF MERCHANTABILITY AND FITNESS FOR A PARTICULAR USE, WITHOUT LIMITATION

# Index

- 3**  
3kHz filter, 15, 16, 29
- A**  
AC power input, 33
- B**  
bandwidth, 31  
bath input, 31  
bessel filter, 2
- C**  
capacity compensation, 2, 25  
circuit description, 38  
clamp signal, 8, 10, 11, 13, 14, 15, 16, 28, 38  
Cmembrane, 26  
compensation, 39  
connecting to a computer, 35  
Conventions, 1  
current clamp, 2, 28, 38  
current clamp recording, 17
- E**  
external clamp, 29
- F**  
fast1, 15, 16, 19, 25, 26, 28  
fast2, 10, 15, 16, 25  
feedback resistors, 2  
filter, 5, 10, 11, 16, 17, 19, 24, 25  
fixed outputs, 25  
functional test, 5
- G**  
gain, 5, 10, 11, 15, 16, 17, 19, 24, 25
- H**  
hold, 28
- I**  
Iclamp, 3, 17  
Ifollow, 3, 17  
instrument operation, 21  
Iresist, 3, 17, 19
- M**  
meter, 5, 9, 11, 14, 16, 18, 19, 22  
mode, 3, 4, 5, 6, 7, 8, 9, 10, 11, 12, 13, 14, 16, 17, 18, 19, 22, 23, 25  
model cell, 4, 6, 7, 8, 10, 11, 12, 13, 14, 15, 18, 19, 26, 34
- O**  
offset, 9, 11, 13, 14, 16, 17, 18, 23, 29  
output, 4, 25
- P**  
positive feedback, 27  
power, 4, 5, 22  
probe, 21, 38  
probe cable, 22  
probe gain, 5, 6, 24, 25  
probe input, 30
- R**  
Raccess, 15, 16, 17, 19, 26, 28  
RMS noise, 3
- S**  
series resistance, 16, 26, 27  
series resistance compensation, 15  
single channel recording, 6  
specifications, 40  
SpeedTest, 3

static, 4

## T

telegraph outputs, 31

track, 9, 14, 23, 29

troubleshooting, 36

## V

Vclamp, 3

Vcomp, 3, 8, 9, 10, 13, 14

voltage clamp, 2, 27

Vtest, 3, 6

## W

whole cell compensation, 15, 26, 27, 28

whole cell recording, 11

10	6/30/06	Initial Document Control Release
11	4/28/10	DCR 201200 Warranty and Company info
12	9/7/10	DCR 201318 New 100 times smaller current clamp
13	1/21/19	DCR 202615 Update manual content.
14	03/19/20	DCR 203316. Updated Warranty
15	5/1/2025	DCR 204239 Updated Warranty