



16-Channel Extracellular Amplifier

3500

INSTRUCTION MANUAL FOR 16-CHANNEL EXTRACELLULAR AMPLIFIER

MODEL 3500

*Each 16-Channel Extracellular Amplifier is
delivered complete with:*

*Sixteen 40" Input Cables
10' USB Cable
Rack Mount Hardware*

*Version 7.0
May 2020*

**A-M Systems,
PO Box 850
Carlsborg, WA 98324
U.S.A.
360-683-8300 800-426-1306
FAX: 360-683-3525
<http://www.a-msystems.com>**

WARNING

THIS EQUIPMENT IS NOT INTENDED FOR USE WITH HUMAN SUBJECTS IN ANY WAY.

Document

The information contained in this manual was as accurate as possible at the time of publishing, but is subject to change without notice and should not be construed as a commitment by A-M Systems. Changes may have been made to the hardware or firmware it describes since publication. A-M Systems, reserves the right to change specifications as required. For the latest information please check our website (<http://www.a-msystems.com>) or contact A-M Systems, directly.

Manual Product Number 950004
Manual Document Number
1027905 Rev 07

All rights reserved. No part of this document may be reproduced by any means without the prior written permission of A-M Systems,

Safety

This instrument is provided with terminal for protective grounding. Before applying power, verify that the correct safety precautions are taken (see the following warnings). In addition, note the external markings on the instrument that are described under Safety Symbols. Do not operate the instrument with its cover removed. Replace fuse only with specified type.

Supply Voltage

This equipment can be operated at 120V/60Hz, or 220V/50Hz, as determined by a labeled switch on the rear panel. Other voltage/frequency combinations are not recommended unless the manufacturer is contacted before first usage.

WARNING

Do not attach a line voltage that does not match the line voltage specified on the rear panel.

Before turning on the instrument, you must connect the protective earth terminal of the instrument to the protective earth conductor of the (mains) power cord. The mains plug must only be inserted in a socket outlet with a protective earth contact.

Service should be performed by trained personnel only. To avoid dangerous electric shock, do not perform any service unless qualified to do so.

Do not operate the instrument in the presence of flammable gases or fumes. Operation of any electrical instrument in such an environment constitutes a safety hazard.

Safety Symbols



The product is marked with this symbol when it is necessary for you to refer to the instruction manual in order to protect against damage to the product.

WARNING

The Warning symbol calls attention to a procedure or practice, which, if not correctly performed could result in injury. Do not proceed beyond a Warning symbol until the indicated conditions are fully understood and met.

CAUTION

The Caution symbol calls attention to a procedure or practice, which, if not correctly performed could result in damage to the product. Do not proceed beyond a caution until the indicated conditions are fully understood and met.

Disclaimer

Software available for this product works with **Windows XP®**, **Windows 7®** and **Windows 10®**

Microsoft and Windows are either registered trademarks or trademarks of Microsoft Corporation in the United States and/or other countries.

TABLE OF CONTENTS

1. GENERAL DESCRIPTION	5
2. FRONT AND REAR PANELS.....	6
FRONT PANEL	6
REAR PANEL	7
3. INSTRUMENT OPERATION	10
INITIAL POWER-UP	10
CHANNEL EDIT SCREEN	10
COPYING CHANNEL SETTINGS TO OTHER CHANNELS.	12
4. TOUCH SCREEN MENUS	13
TOOLBAR	13
MAIN MENU SCREEN	14
LOAD SCREEN	15
SAVE SCREEN	16
SET STARTUP PROGRAM SCREEN	17
INSTRUMENT NAME SCREEN	18
REFERENCE SCREEN	19
NOTCH FILTER SCREEN	20
STIMULATION INPUT SCREEN	21
CALIBRATION SIGNAL	22
LCD SETTINGS SCREEN	22
CALIBRATE LCD SCREEN	23
STARTUP PAGE SCREEN	24
VERSION SCREEN	24
CHANNEL EDIT SCREEN	25
8-CHANNEL VIEW SCREEN	26
16-CHANNEL VIEW SCREEN	27
OUTPUT MONITORS AND CALIBRATION SIGNAL SCREEN	27
5. PC CONTROL SOFTWARE	29
WINDOWS 10	29
USING THE CONTROL SOFTWARE	35
6. EXTERNAL TTL CONTROL	38
7. SPECIFICATIONS	41
8. WARRANTY	42
Figure 1. Power switch	6
Figure 2. Touch Screen Display	6
Figure 3. Output Monitor	6
Figure 4. Channel Signal Input	7
Figure 5. Channel Output	7
Figure 6. Stimulation Inputs	7
Figure 7. External TTL Control	7
Figure 8. USB Connector	8
Figure 9. Common Reference Connector	8
Figure 10. Diagram of Ganged Output Connector	8
Figure 11. AC Power Input / Line Switch	9
Figure 12. Channel Edit Screen	11
Figure 13. Toolbar	13
Figure 14. Main Menu Screen	14
Figure 15. Load Screen	15
Figure 16. Save Screen	16
Figure 17. Set Startup Screen	17
Figure 18. Instrument Name Screen	18
Figure 19. Reference Screen	19
Figure 20. Notch Filter Screen	20
Figure 21. Stimulation Input Screen	21
Figure 22. Contrast Screen	22
Figure 23. Calibrate LCD Screens	23
Figure 24. Start-up Page	24
Figure 25. Version Screen	24
Figure 26. Channel Edit Screen	25
Figure 27. 8-Channel View Screen One	26
Figure 28. 8-Channel View Screen Two	26
Figure 29. 16-Channel View Screen One	27
Figure 30. 16-Channel View Screen Two	27
Figure 31. Monitor and Calibration Signal Screen	28
Figure 32. PC Software	35
Figure 33. Instrument Screen when PC Program is in Control	36
Figure 34. Toolbar with TTL Icon	38
Figure 35. Diagram of External TTL Connector Pin Layout	39
Table 1. Toolbar Icons	13
Table 2. TTL State Table for controlling MODE	38
Table 3. External TTL Connector Pin Assignments	39

LIST OF TABLES AND FIGURES

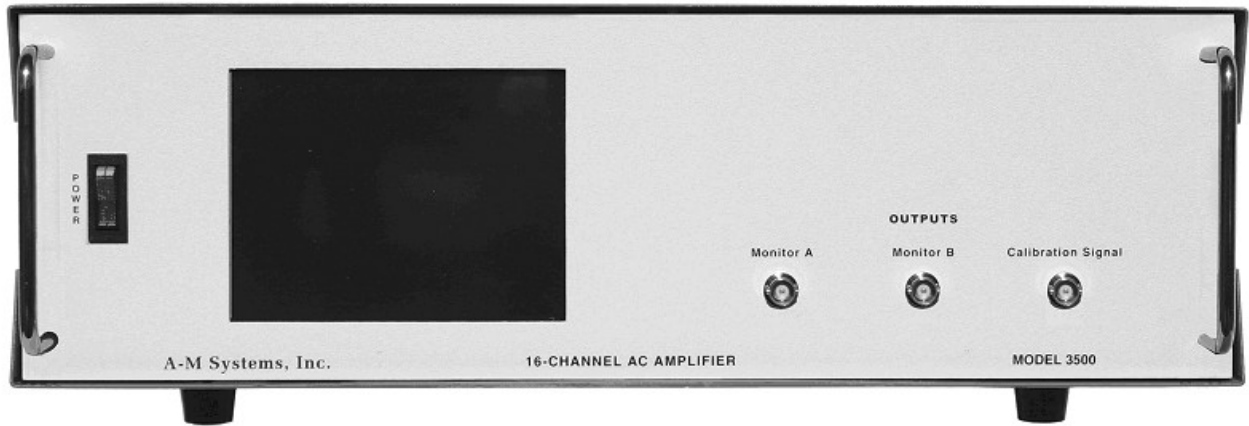

1. General Description

The Model 3500 contains 16 low noise, high gain full-featured extracellular amplifiers, or channels, designed for amplifying microvolt-level input signals. All parameters can be controlled via the unit's touch screen LCD display on the front panel or via a USB link to a personal computer running a supplied Windows® operating system compatible control program. In addition, external TTL pulses can set each channel's operation mode.

Each channel has significant signal conditioning capabilities, including low and high pass filtering, a line-frequency notch filter, and gain. Each channel can record differentially between its two input leads, or can be set to record referenced to ground, or an external reference source.

In addition, each channel can pass an externally generated signal to the connected electrode. This is useful for stimulating local recording sites without having to physically disconnect the amplifier from the electrodes. If desired, it is possible to temporarily blank any channel, or ground its inputs and turn off its outputs, in order to prevent signal saturation during stimulation procedures.

Additional useful features include the ability to store up to five sets of 16-Channel parameter files within the instrument in order to enable multiple users to recall their individual experiment protocols without having to re-program the instrument. A built-in calibration signal source can be used to calibrate the amplifier/electrode combination. Two output monitors provide easy front-panel access to the output of any channel for immediate analysis on an oscilloscope.

A supplied Windows® operating system compatible control program controls all features of the amplifier via a USB port (cable included). The program also enables the storage of an unlimited number of 16-Channel parameter files, as well as provides a real-time notepad that logs changes in parameter settings or experimenter-added notations.

The Model 3500 16-Channel Extracellular Amplifier is not intended for clinical or operating room measurements in human subjects.

2. Front and Rear Panels

This chapter describes the front and rear panel controls and connectors on the Model 3500. Chapters 3 and 4 describe the individual screens available on the touch-screen LCD interface.

When you receive your Model 3500, confirm that everything in the packing list is included. Make sure there are no obvious signs of internal damage, such as rattling. Pick up the amplifier and tilt it gently from side to side, and listen for anything that might be loose. If you hear any suspicious noises, contact A-M Systems immediately.

Front Panel

Power

The model 3500 has an illuminated power supply switch that will light when line power is passing through it. If it does not light then there is no line power to the amplifier. Upon powering up, the large touch-screen LCD display should illuminate.

Figure 1. Power switch



Display

The liquid crystal display (LCD) on the Model 3500 is a touch-screen interface whose input determines the settings for all of the Model 3500 functions.

Figure 2. Touch Screen Display



Output Monitor / Calibration Signal

As the main amplifier outputs are located on the rear panel, the Model 3500 provides two user defined **OUTPUT MONITORS** on the front panel for convenience. Any channel output can be linked to either of the two BNC connectors (labeled **A** and **B**) by altering the settings on the **OUTPUT MONITOR** control screen.

Figure 3. Output Monitor

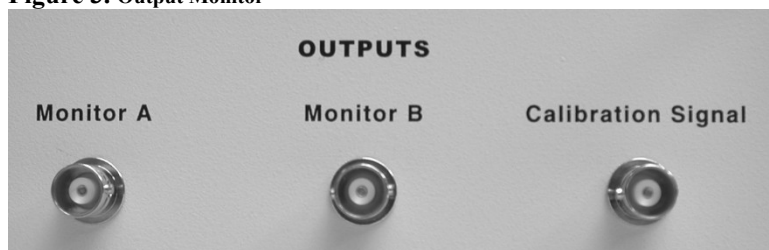

The **CALIBRATION SIGNAL** BNC connector provides a signal (1.0 kHz sine wave, with user adjustable amplitude) for calibrating the instrument.

Rear Panel

Channel Signal Input

This black 3-pin connector is the signal input connector for the Model 3500. Pin 1 (upper left) is the “-” lead, pin 2 (bottom left) is the “+” lead, and pin 3 (middle right) is the grounded shield (This can be a non-grounded driven shield if desired. Contact A-M Systems for more information. Model 3500s can be shipped with either a gray 3-conductor wire, or a black 4-conductor wire. On the gray cable, the red wire is the “+” lead, the white wire is the “-” lead, and the silver braid is the grounded shield. On the black cable, the red wire is the “+” lead,

the white wire is the “-” lead, and the black wire or the silver braid is the grounded shield.

Figure 4. Channel Signal Input

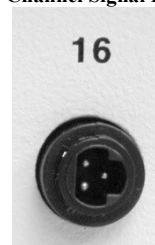

Channel Output

This BNC connector provides the amplified and filtered output signal.

Figure 5. Channel Output



Stimulation Inputs

STIM1 and **STIM2** BNC connectors are signal inputs. Connecting an external signal source to STIM1 will enable stimulation signals to be delivered to Channels 1-8. Connecting an external signal source to STIM2 will enable stimulation signals to be delivered to Channels 9-16. If desired, the two stimulus input connectors can be linked internally, so the same external stimulus source can be used to stimulate any or all of the 16 channels. In this case, STIM1 is connected to stimulation bus. See Chapter 4: Stimulation Input Screen for additional information.

Figure 6. Stimulation Inputs



External TTL Control Input

Figure 7. External TTL Control

This 37-pin connector provides the user with the ability to control Channel Mode via externally generated TTL signals. A complete listing of the pin-outs and how they function is listed in Chapter 6: External TTL Control.



USB Connector

This connector enables a personal computer running a supplied Windows® operating system compatible control program to control the Model 3500 by attaching it to an available USB port on the computer using the USB cable supplied with the instrument.

Figure 8. USB Connector



Common Reference Connector

Input to this BNC can serve as a common reference for any or all of the amplifier channels. See Chapter 4: Common Reference for more information.

Figure 9. Common Reference Connector



Ground Connector

The center conductor of this BNC (Figure 10) is the amplifier's chassis (signal) ground.

Ganged Output Connector

Figure 10. Diagram of Ganged Output Connector

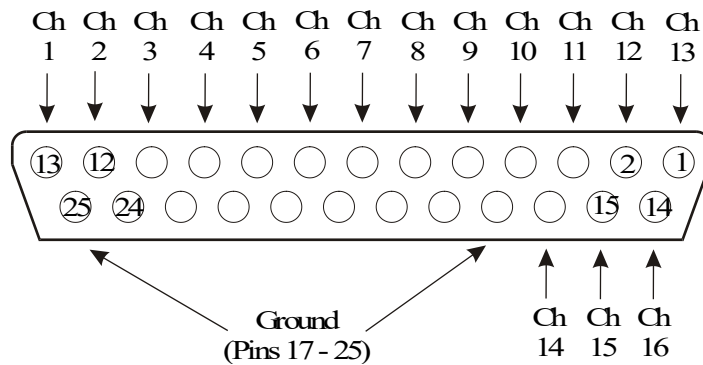

This 25-pin output connector is provided for researchers who prefer to use a massed output cable, rather than the provided individual BNC Output connectors. No cable is provided with the instrument to mate with this connector.

WARNING

AC Power Input

This instrument has a terminal for protective grounding. Before applying power, verify that the correct safety precautions are taken. In addition, note the external markings on the instrument that indicate line voltages. Do not operate the instrument with its covers removed. Replace fuse only with specified type. Check that the correct voltage for your country is indicated on the back of the unit. The Model 3500 should be delivered with the appropriate mains power voltage set, at either 100-120 volts or 220-240 volts. A red slide switch located on the back panel just above the power input determines this setting. Slide the switch into the correct position if the wrong voltage is displayed. Do not attach a line voltage that does not match the line voltage indicated on the rear panel. Before turning on the instrument, you must connect the protective earth terminal of the instrument to the protective earth conductor of the (mains) power cord. The mains plug must only be inserted in a socket outlet with a protective earth contact.

Figure 11. AC Power Input / Line Switch



3. Instrument Operation

Initial Power-Up

After unpacking your instrument and verifying that it is configured for the proper AC Power line values, turn the instrument on using the front panel power switch. The touch-screen LCD should illuminate and the A-M Systems logo should be displayed briefly as the on-board software loads.

After the initial software loads, the Calibrate Screen Process will begin. By touching the indicated targets, the software responsible for tracking user input will determine the user's local pressure maxima when they press the screen, and will adjust subsequent target hot areas accordingly, thereby increasing the accuracy of the screen for that particular user.

After completing the calibration process, the unit will display the MAIN MENU. For purposes of the ensuing discussion, move directly to the CHANNEL EDIT screen by pressing the **1** in the toolbar at the top of the LCD display. The navigation toolbar is described in detail in Chapter 4.

Channel Edit Screen

The CHANNEL EDIT SCREEN is used to edit the parameters of the amplifier channels. The top line of the CHANNEL EDIT SCREEN (as well as all other screens) is the TOOLBAR, which contains navigation icons that allow the user to navigate to key screens. The horizontal SINGLE CHANNEL SELECT LIST bordered by left- and right-facing arrows selects the channel whose current settings are displayed in the vertical parameter lists (High Pass, Low Pass, Gain, Notch, Reference, and Mode). The channel to be displayed can be selected by pressing the arrows at either end of the list, or the channel number itself. Pressing any value displayed in any list will highlight that value, and will immediately set that channel's parameter to the selected value. Thus, this is the equivalent action of turning a dial or a knob on traditional amplifiers. If more settings are available than can be displayed in a list, an up or down arrow will be displayed which will shift the list accordingly if pressed.

Please select Channel 1. This can be done either by scrolling the selected value using the Arrow buttons, or by touching the "1" in the scroll list. When selected, "1" will be highlighted.

Figure 12. Channel Edit Screen

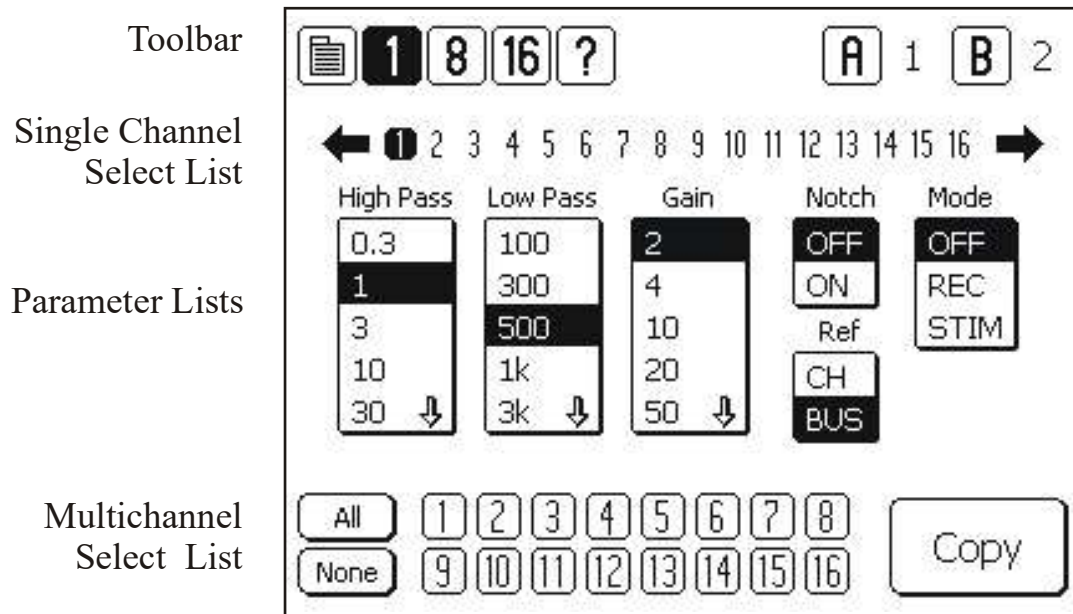

High Pass

Each channel has a High Pass filter that can be set to any of the following values: 0.3, 1.0, 3.0, 10.0, 30.0, 100.0, 300.0, and 500.0 Hz.

Low Pass

Each channel has a Low Pass filter that can be set to any of the following values: 0.1, 0.3, 0.5, 1.0, 3.0, 5.0, 10.0, and 20.0 kHz.

Gain

The gain of each channel can be set to any of the following values: 2, 4, 10, 20, 50, 100, 200, 500, 1k, 2k, 5k, 10k, and 20k.

Notch

A filter can be introduced or removed from each channel's signal path in order to reduce AC line frequency noise if necessary. ON implements the filter. OFF removes the filter. The NOTCH filter can be tuned for the AC line frequency in the country where the Model 3500 is being used by accessing the NOTCH FILTER PAGE via the MAIN MENU (See Chapter 4).

Ref

Each Channel can either record differentially by comparing the input signals on its (+) and (-) leads, or record the difference between its (+) input lead and the signal on the Common Reference Bus. CH indicates that the channel is recording vs its own (-) lead and is not connected to the COMMON REFERENCE BUS. BUS indicates that the channel is connected to the COMMON REFERENCE BUS. The signal on the COMMON REFERENCE BUS will either be Ground, or the signal present at the EXTERNAL REFERENCE CONNECTOR on the rear panel. This is determined by the setting on the REFERENCE SCREEN (See Chapter 4 for details).

Note that all of the channels on the COMMON REFERENCE BUS will either be grounded or referenced to the external connector. It is not possible to have some channels grounded, and some channels referenced to the external Reference connector using this approach.

Mode

Each channel can be operated in one of three modes. OFF “blanks” the channel: signal leads from the electrode are disconnected internally from the amplifier inputs and that channel’s amplifier inputs are grounded. This is useful when one is expecting a large artifact that might distort or saturate the channel’s amplifier, such as what might occur during stimulation on that channel or via electrodes close to that channel’s own electrode. REC connects the electrode leads to the channel’s amplifier input leads. STIM disconnects the electrode leads from the amplifier input leads, and connects them to one of two STIM buses to allow an external signal to be passed through to that electrode. STIM also grounds the channel’s amplifier input leads. For complete control of the STIM parameters, additional options need to be set that are available from the MAIN MENU.

At this point, Channel 1 is fully defined and operational.

Copying Channel Settings to other Channels.

If desired, it is possible to copy the parameters of this selected channel to any or all of the remaining channels. Simply select which channels you would like the parameters copied to by highlighting the channel numbers in the double rows of the MULTICHANNEL SELECT LIST at the bottom of the EDIT SCREEN. ALL selects all the channels; NONE clears the channels selected. Pressing COPY will then transfer the channel parameters to the selected channels.

At this point, the unit is defined and functional on all channels. Further details on all instrument functions are described in the next chapter.

4. Touch Screen Menus

This chapter will present screen captures of each menu, along with detailed descriptions of the function of each button. Some of this material has been previously presented.

Toolbar

The top line of just about every screen is a common navigation toolbar. This toolbar enables the user to jump to any of the main screens from any other screen at any time during the experiment. Table 1 lists the function of each of the buttons on the navigation toolbar.

Figure 13. Toolbar

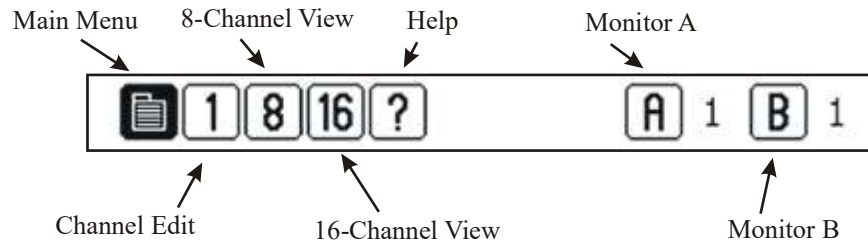



Table 1. Toolbar Icons

ICON	NAME	FUNCTION
	Menu	Loads main control screen for program / instrument settings
1	1 Ch Edit	Edit screen for all amplifier parameters
8	8 Ch View	View screen that displays all settings for a single channel, 8 channels at a time
16	16-Ch View	View screen that displays major settings for a single channel, 16 channels at a time
?	Help	Display list of icons and their functions, along with other help information links
TTL	TTL	Displayed when amplifier controlled by external TTL-level signals (not displayed above)
A	Monitor A	Displays Output Monitor A setting; Calls Monitor setting screen.
B	Monitor B	Displays Output Monitor B setting; Calls Monitor setting screen.

Main Menu Screen

Options on the MAIN MENU screen are grouped according to four main functions: Program, Amplifier, User Prefs, and Firmware settings. **Program** functions include loading and saving 16-channel parameter sets for later recall (LOAD, SAVE), determining which of the stored parameter sets will be initially loaded upon instrument boot-up (SET START-UP PROGRAM), and naming the instrument (INSTRUMENT NAME). **Amplifier** functions include setting the Common Reference type (REFERENCE), applying the Notch filter if necessary (NOTCH FILTER), determining required parameters for passing stimulating current through the instrument (STIMULATION INPUT), and generating a signal to be used to calibrate the amplifier or other instruments (CALIBRATION SIGNAL). **User Prefs** options include a variety of controls related to the LCD display (LCD SETTINGS), calibrating the touch-screen for a given user's finger placement (CALIBRATE LCD), and determining the preferred STARTUP PAGE. **Firmware** options enable the user to identify which version of firmware and software is currently loaded on the instrument.

Additional details on each of these screen options follow.

Figure 14. Main Menu Screen

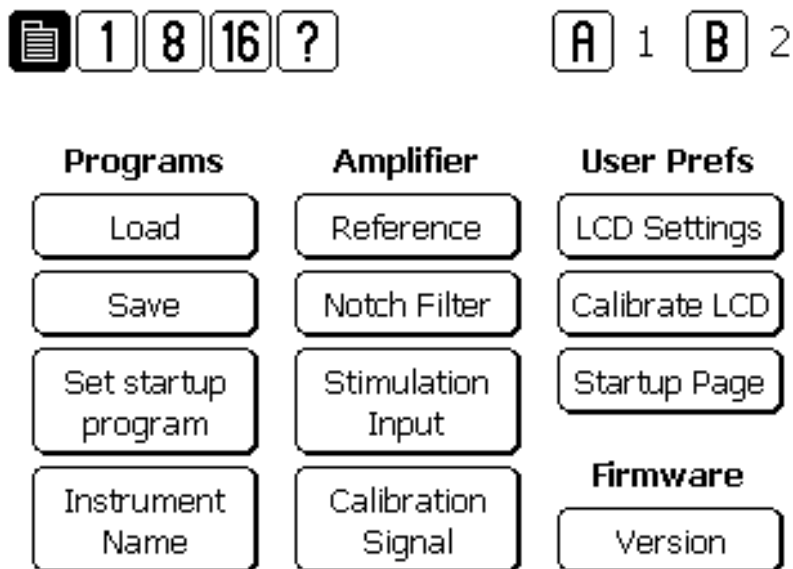

Load Screen

LOAD screen displays a list of five memory locations that are stored within the Model 3500 and are saved even after AC power to the unit is shut off. These memory locations store the critical parameters of all 16-channels in a single file. A memory location is selected by highlighting the parameter set name (or program) name. A parameter set is loaded into active file set by pressing LOAD. After loading the new parameter file, the instrument will return to 16-CHANNEL VIEW. CANCEL will cancel the selection, not load any new parameters, and return the instrument to the MAIN MENU).

Figure 15. Load Screen

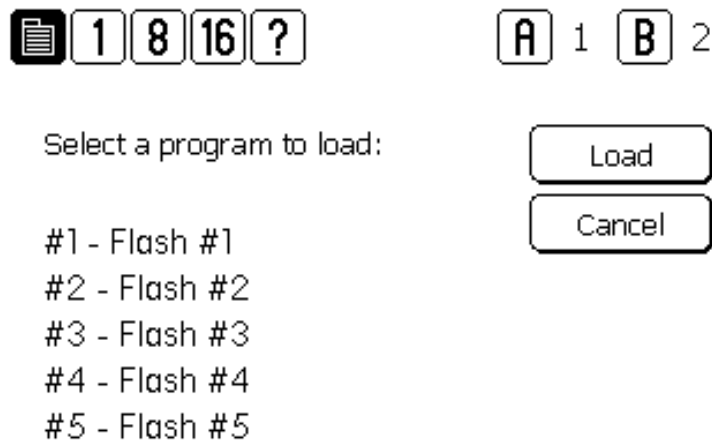

Save Screen

SAVE screen displays the list of the five parameter set programs currently stored on-board in internal memory. Pressing NEXT after selecting one of the program locations (#1-5) by pressing on the parameter set name will lead to a “keyboard” screen that will enable the user to either accept the name as is, or enter a new name. Pressing ENTER on the keyboard will store the currently loaded parameter values in the program location, overwriting whatever program was there previously, with no chance at recalling the previously stored program. After storing the parameters, the unit will return to the 16-CHANNEL VIEW screen. Pressing CANCEL on the keyboard will return the instrument to the MAIN MENU, without writing the current parameter values in any memory location. SHIFT will toggle the screen from capital letters to lower case letters.

Figure 16. Save Screen

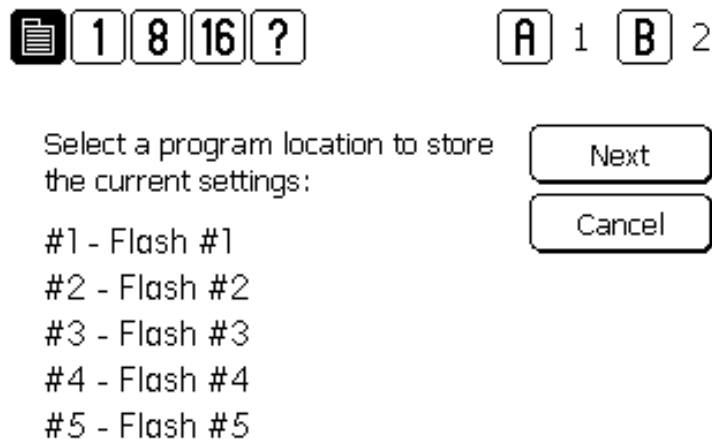

Set Startup Program Screen

SET STARTUP PROGRAM screen displays the list of the five parameter set programs currently stored on-board in internal memory. Pressing OK after selecting one of the program locations (#1-5) by pressing on the parameter set name will store that memory location as the location to load every time the instrument is turned on. OK sets the selected program name at the startup program. CANCEL terminates the process and makes no change to the current startup program selection.

Figure 17. Set Startup Screen

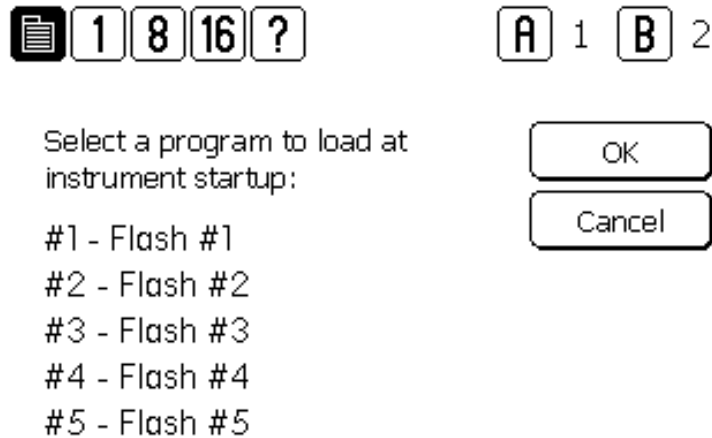

Instrument Name Screen

This screen loads the “keyboard”, and enables the user to name their instrument. Setting the instrument name can help the user to identify individual instruments when multiple instruments are connected to a single computer to be controlled using the supplied software. ENTER stores the name and the unit returns to the MAIN MENU. CANCEL does not store the new name, and the unit returns to the MAIN MENU.

Figure 18. Instrument Name Screen

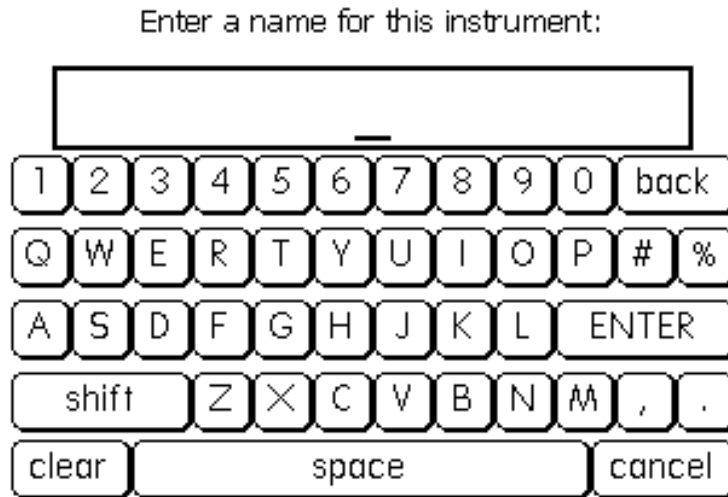

Reference Screen

Settings on the REFERENCE screen determine which channels use the Common Reference Bus (path), and what that reference bus is connected to. The bus can be connected to either the EXTERNAL REFERENCE BNC located on the rear panel, or AMPLIFIER GROUND, in which case the common reference path is internally grounded to the amplifier's signal ground. Highlighting a channel by pressing the channel number connects that channel's (-) input lead to the common reference bus. DONE returns the unit to the last displayed channel screen (CHANNEL EDIT, 8-CHANNEL, or 16-CHANNEL VIEW).

Figure 19. Reference Screen

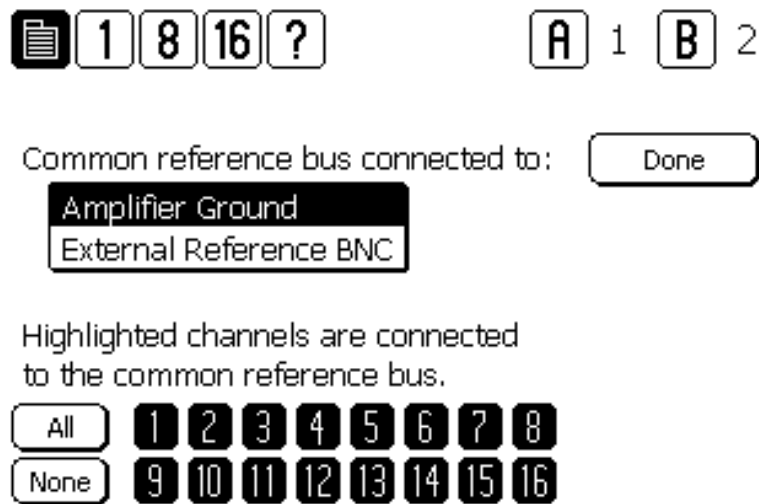

Notch Filter Screen

The NOTCH FILTER screen is used to enable or disable a filter tuned for line frequency noise. AC Power can be either be 50Hz or 60Hz depending on the country where the instrument is being used. Highlighting the appropriate value sets each channel's NOTCH FILTER for that frequency. Highlighting a channel in the list of 16 channels will activate that channel's NOTCH FILTER. DONE returns the unit to the last displayed channel screen (CHANNEL EDIT, 8-CHANNEL VIEW, or 16-CHANNEL VIEW).

Figure 20. Notch Filter Screen

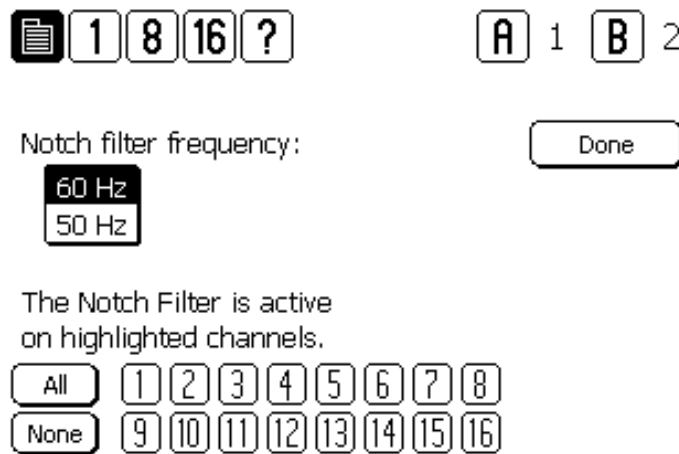

Stimulation Input Screen

Users can pass an externally generated stimulus directly to the input leads of any or all channels. To do so, the individual channel must be connected to a stimulation bus. Select the channel(s) to be connected using the selection buttons on the STIMULATION INPUT screen. Alternatively, the channel can be placed in STIM mode by setting the MODE on the CHANNEL EDIT screen.

Figure 21. Stimulation Input Screen

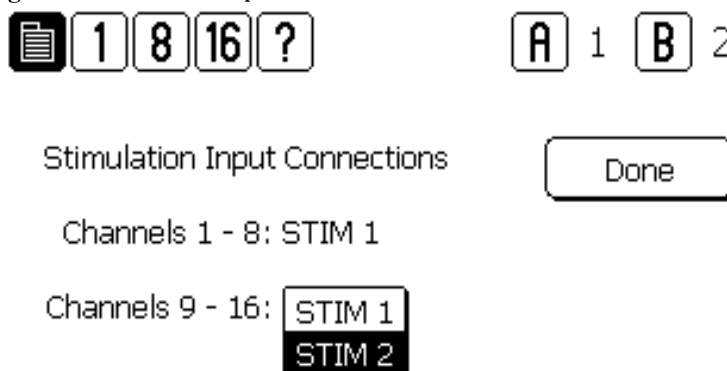

The Model 3500 has two separate stimulation signal buses (STIMULATION INPUT BNC 1 and STIMULATION INPUT BNC 2) that correspond to two groups of channels. Channels 1 through 8 can be connected to STIMULATION INPUT BNC 1. Channels 9 through 16 can be connected to STIMULATION INPUT BNC 2. This enables the user to stimulate with two different stimulation signals if so desired, as long as the channels to be stimulated with the different signals are on the two different buses. If desired, the two buses can be linked together internally, by highlighting the STIM 1 option next to the Channels 9-16 label on the screen or by applying a 5V signal to pin 18 on the rear panel's EXTERNAL TTL CONNECTOR. When this option is selected, STIMULATION INPUT BNC 2 is disabled, and all channels will be connected to STIMULATION INPUT BNC 1. The default setting for Channels 9-16 is STIM 2.

Once placed in stimulation mode, the signal leads from the subject are connected to the external stimulation input BNCs, and the input leads to that channel's amplifier are grounded.

It should be noted that if multiple channels are connected to a single stimulation bus at one time, then the effective resistance load seen by the voltage source will be the equivalent of multiple parallel resistances. Therefore, the current flow through each channel will not be identical (the actual current flow will depend on the resistance of the electrode leads). Thus, each channel will not be undergoing identical conditions even though they are simultaneously connected to the same signal source. Similarly, if the stimulation signal is a constant current signal, then the multiple parallel resistances generated by the channels might also result in different current flows through each electrode, depending on the various electrode impedances.

NOTE: When a channel is connected to the STIMULATION SIGNAL BUS, then the channel is simultaneously blanked as well. In other words, the input leads from the channel will be disconnected from that channel's amplifier inputs, which will in turn be grounded. It is not possible to record on a channel while stimulating that channel's input leads.

DONE returns the unit to the last displayed channel screen (CHANNEL EDIT, 8-CHANNEL VIEW, or 16-CHANNEL VIEW).

Calibration Signal

See OUTPUT MONITORS AND CALIBRATION SIGNAL SCREEN later in this chapter.

LCD Settings Screen

This screen allows the user to adjust characteristics of LCD. Moving the CONTRAST slider adjusts the contrast of the screen. Moving the BACKLIGHT slider adjusts the brightness of the screen. The REVERSE LCD button will reverse the color of the screen from dark letters on a light background, to light letters on a back background, and back again.

Figure 22. Contrast Screen

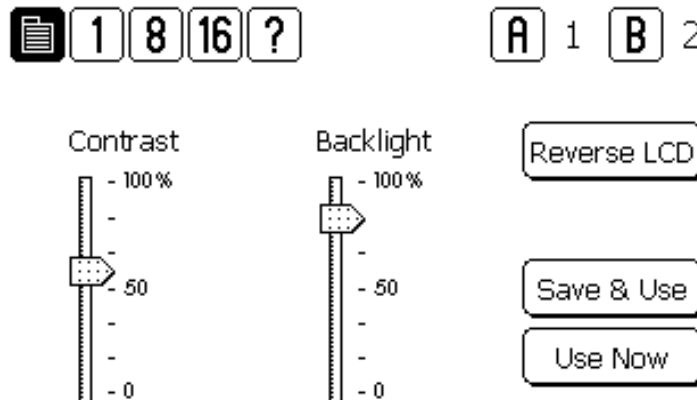

Calibrate LCD Screen

The CALIBRATE LCD screen enables the user to tune the touch screen performance to match their touching style. Some individuals will consistently press slightly above the button, others below for example. This protocol teaches the instrument how to respond to the current user. After initiating the protocol, the user is required to press the targets in succession. When calibrated, touch screen performance is maximized. At any time, one can re-calibrate the screen. Upon powering up the unit, the previous calibration file will be maintained. Users can determine if the calibration protocol should be initiated at the beginning of each session following power up, or only upon request by selecting the appropriate field by selecting the appropriate value on the STARTUP PAGE screen.

Figure 23. Calibrate LCD Screens

Touch the center of
the target to calibrate.



Startup Page Screen

The STARTUP PAGE enables users to determine whether or not the screen calibration protocol is initiated every time the instrument is turned on, and which screen will be initially displayed.

Figure 24. Start-up Page

1 8 16 ? A 1 B 2

Calibrate LCD at startup:

YES
NO

Save
Cancel

Highlighted page will be loaded at startup.

1 8 16 ?

Version Screen

The VERSION screen displays the latest version numbers of the software and hardware the Model 3500 currently uses. This diagnostic tool should be used before contacting A-M Systems for service.

Figure 25. Version Screen

1 8 16 ? A 1 B 2

Firmware Versions OK

Processor Build: 1

Display Build: 3

Serial Number:

Channel Edit Screen

The CHANNEL EDIT SCREEN is the main screen used to edit the major parameters of the 16 amplifier channels. The top line of the CHANNEL EDIT SCREEN is the TOOLBAR, which contains navigation icons that allow the user to navigate to key function screens. The horizontal SINGLE CHANNEL SELECT list bordered by left- and right-facing arrows selects the channel whose current settings are displayed in the vertical parameter lists (High Pass, Low Pass, Gain, Notch, Common, and Mode). Channels can be selected by pressing the arrows at either end of the list, or the channel number itself. Pressing any value displayed in any list will highlight that value, and will immediately set that channel's parameter to the selected value. This is the equivalent action of turning a dial or a knob on traditional amplifiers. If more settings are available than can be displayed in a list, an up or down arrow might be displayed which will shift the list accordingly if pressed.

Figure 26. Channel Edit Screen

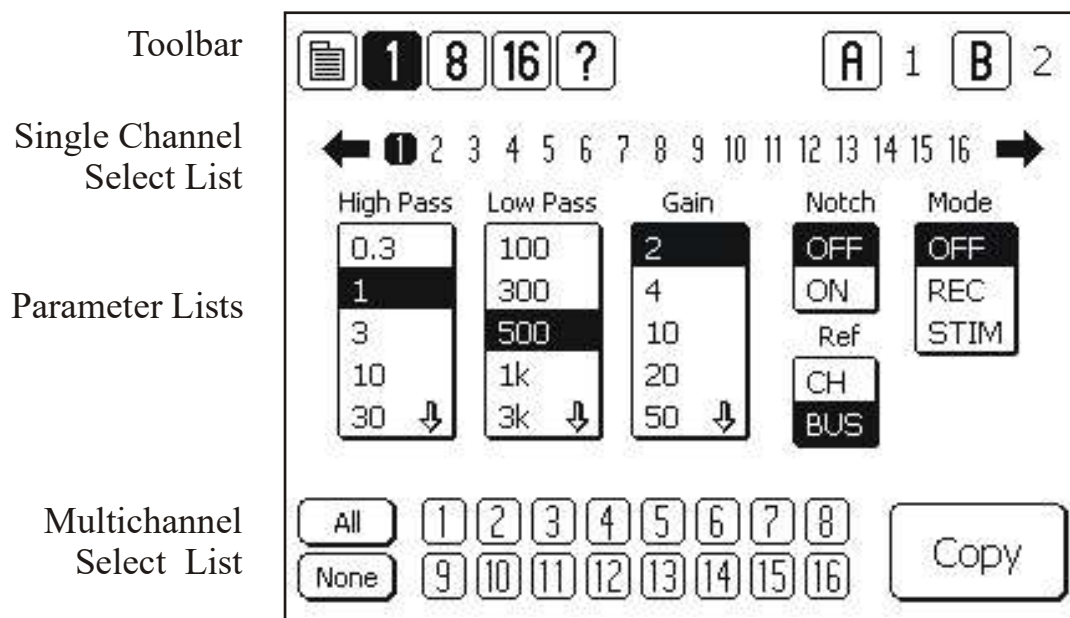

If desired, it is possible to copy the parameters of this selected channel to any or all of the remaining channels. Select which channels you would like the parameters copied to by highlighting the channel numbers in the double rows of the MULTICHANNEL SELECT LIST at the bottom of the EDIT SCREEN. ALL selects all the channels; NONE clears the channels selected. Pressing COPY will then transfer the channel parameters to the selected channels.

If multiple channels are selected on either the 8 or 16 CHANNEL VIEW SCREEN prior to entering the CHANNEL EDIT SCREEN, then the values displayed in the parameter lists will reflect those values currently in operation of the lowest number channel in the selected channel group. For example, if Channels 4, 5, 9, and 13 are selected, and then the CHANNEL EDIT SCREEN is displayed, Channels 4, 5, 9, and 13 will be highlighted in the MULTICHANNEL SELECT LIST, and the values of channel 4 will be highlighted in the parameter list.

8-Channel View Screen

Pressing 8 at the top of any screen will display the 8-CHANNEL VIEW screen.

Figure 27. 8-Channel View Screen One

Ch	HP	LP	Gain	Notch	Ref	Mode
1	3	5k	2	OFF	CH	OFF
2	3	5k	2	OFF	CH	OFF
3	3	5k	2	OFF	CH	OFF
4	3	5k	2	OFF	CH	OFF
5	3	5k	2	OFF	CH	OFF
6	3	5k	2	OFF	CH	OFF
7	3	5k	2	OFF	CH	OFF
8	3	5k	2	OFF	CH	OFF

Figure 28. 8-Channel View Screen Two

Ch	HP	LP	Gain	Notch	Ref	Mode
9	3	5k	2	OFF	BUS	OFF
10	3	5k	2	OFF	BUS	OFF
11	3	5k	2	OFF	BUS	OFF
12	3	5k	2	OFF	BUS	OFF
13	3	5k	2	OFF	BUS	OFF
14	3	5k	2	OFF	BUS	OFF
15	3	5k	2	OFF	BUS	OFF
16	3	5k	2	OFF	BUS	OFF

On these two screens all the parameters of eight channels can be viewed at once. Pressing the arrow in the lower right-hand corner will switch the display to the other eight channels (Channel Numbers 1-8 on one screen; Channels 9-16 on the other).

On this display, it is possible to select channels to edit by pressing on the channel numbers. Selected channels will be highlighted. Pressing the “1” button at the top of the screen will display the CHANNEL EDIT SCREEN. Note that if channels are selected on the 8-CHANNEL SCREEN prior to moving to the CHANNEL EDIT SCREEN, those same channels will now be selected in the in the double rows of that screen’s MULTICHANNEL SELECT LIST.

Figure 30. 16-Channel View Screen Two

	1	8	16	?	A	1	B	2
Ch	Notch	Ref	Mode	Ch	Notch	Ref	Mode	
1	OFF	CH	OFF	9	OFF	BUS	OFF	
2	OFF	CH	OFF	10	OFF	BUS	OFF	
3	OFF	CH	OFF	11	OFF	BUS	OFF	
4	OFF	CH	OFF	12	OFF	BUS	OFF	
5	OFF	CH	OFF	13	OFF	BUS	OFF	
6	OFF	CH	OFF	14	OFF	BUS	OFF	
7	OFF	CH	OFF	15	OFF	BUS	OFF	
8	OFF	CH	OFF	16	OFF	BUS	OFF	←

16-Channel View Screen

Pressing 16 at the top of any screen will display the 16-CHANNEL VIEW screen.

The first 16-Channel view displays the most commonly changed parameters (High Pass Filter, Low Pass Filter, and Gain settings) of all 16 channels.

Pressing the arrow in the lower right-hand corner will switch the display to the other parameters (Notch, Common Reference, and Mode).

Figure 29. 16-Channel View Screen One

	1	8	16	?	A	1	B	2
Ch	HP	LP	Gain	Ch	HP	LP	Gain	
1	3	5k	2	9	3	5k	2	
2	3	5k	2	10	3	5k	2	
3	3	5k	2	11	3	5k	2	
4	3	5k	2	12	3	5k	2	
5	3	5k	2	13	3	5k	2	
6	3	5k	2	14	3	5k	2	
7	3	5k	2	15	3	5k	2	
8	3	5k	2	16	3	5k	2	

On this display, it is possible to select channels to edit by pressing on the channel numbers. Selected channels will be highlighted. Pressing the “1” button at the top of the screen will display the CHANNEL EDIT SCREEN. Note that if channels are selected on the 16-CHANNEL SCREEN prior to moving to the CHANNEL EDIT SCREEN, those same channels will now be selected in the in the double rows of that screen’s MULTICHANNEL SELECT LIST.

Output Monitors and Calibration Signal Screen

For user convenience, the Model 3500 has two channel output monitors (BNC connectors A and

B) available on the front panel. Pressing “A” or “B” at the top right-hand corner of any screen will display the CHANNEL MONITOR and CALIBRATION SIGNAL Screen. This screen enables the user to select which channels’ output will be mirrored to the front panel BNCs in order to provide easy monitoring on an oscilloscope. The signal out at the BNC is the same as the output signal available at the rear panel BNC.

The calibration signal is a 1 kHz sine wave that is present at the CALIBRATION SIGNAL BNC on the front panel. This screen enables the user to select appropriate signal amplitude from one of four levels. Pressing ON will activate the calibration signal. Pressing OFF will deactivate the calibration signal.

Figure 31. Monitor and Calibration Signal Screen

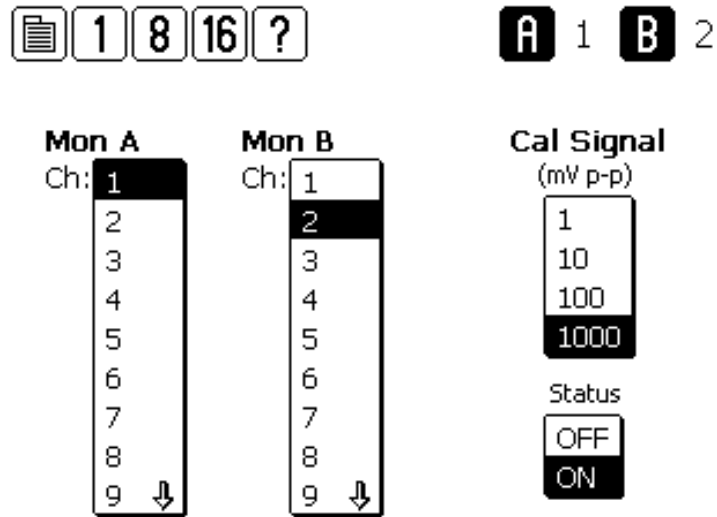

5. PC Control Software

The Model 3500 can be controlled by Windows compatible software that is available for download at www.a-msystems.com. The downloadable control software runs on Windows® 10, 7, and, Windows® XP. The section that follows covers installation procedures for Windows 10. If you require instructions for previous versions of Windows, please contact A-M Systems.

This software controls all features of the amplifier via a USB port.

Windows 10

Download the most recent version of Model 3500 control software from www.a-msystems.com. The software is located on the Model 3500 webpage.

Open the compressed file.

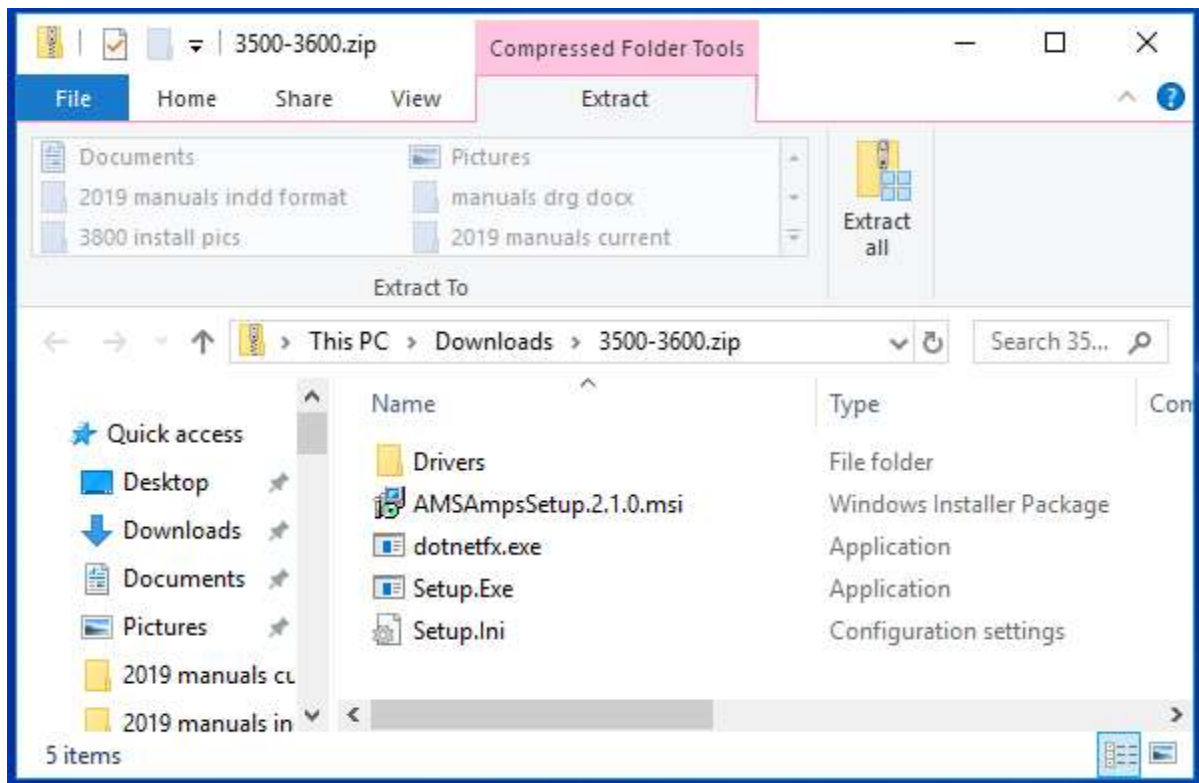

Extract the files to a new folder:

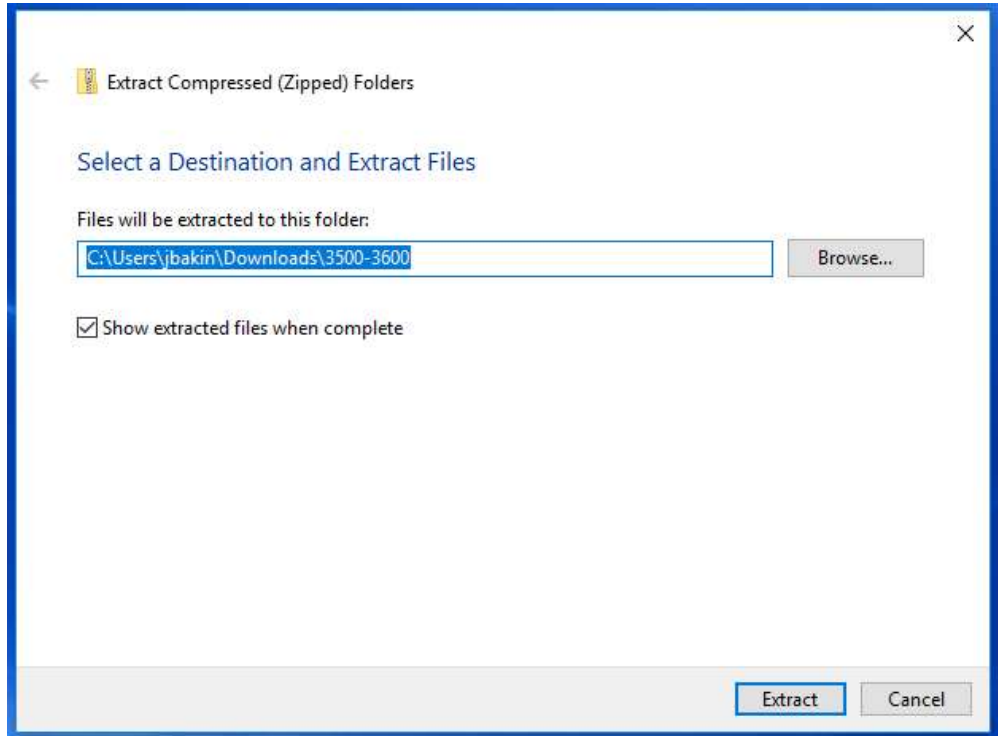

The Model 3500 control software requires the Microsoft® .NET Framework version 1.1 or later to function. Once extracted, double click to run the “dotnetfx.exe” file.

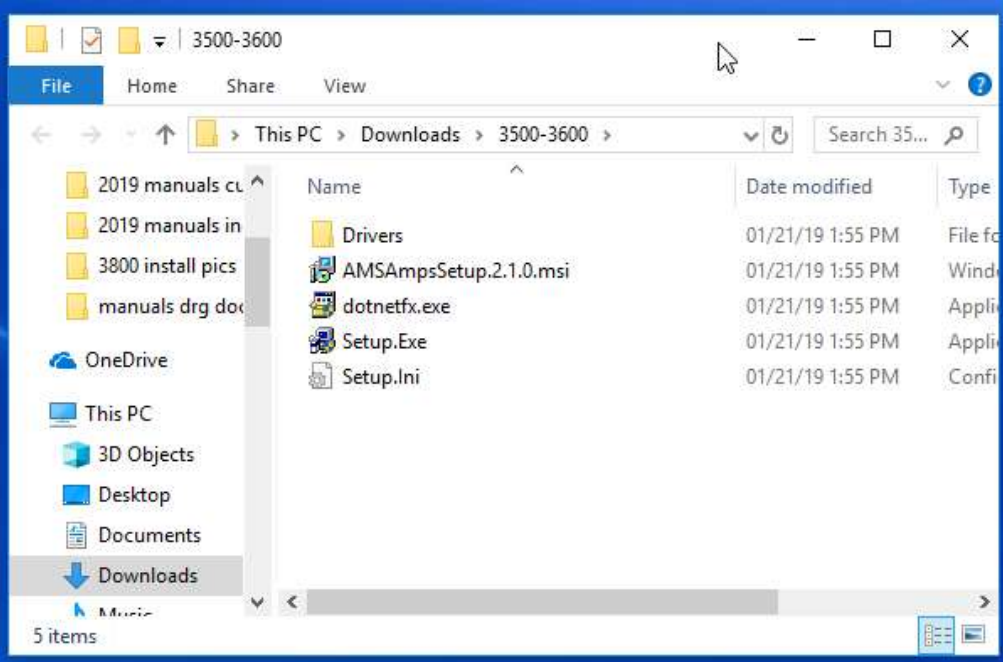

You might see a Windows dialog box asking for permission to allow software to be installed. Answer yes to proceed, and then continue to install the .NET framework.

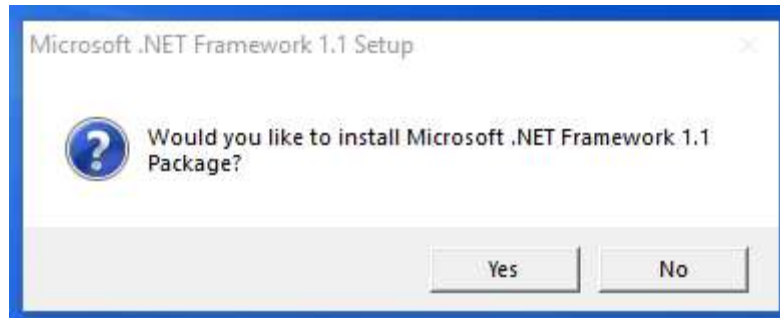

An additional dialog box to begin .NET installation. Select "I agree" to proceed.



After .Net is installed, a dialog box will appear. Click "OK" to close.

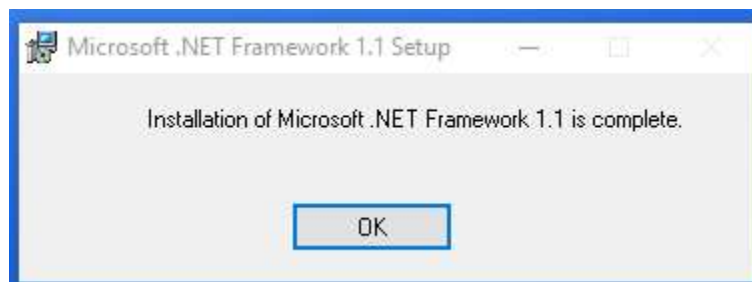

Return to the installation software folder and double click on “Setup.exe” to install the Model 3500 Control Software.

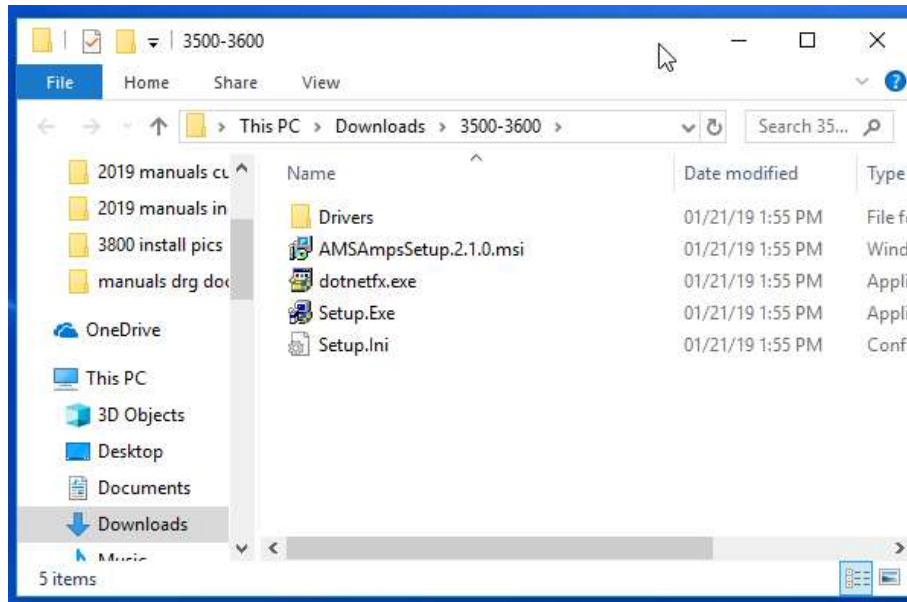

The Model 3500 control software installation wizard will ask for permission to install:



A dialog box suggesting the file location will open.

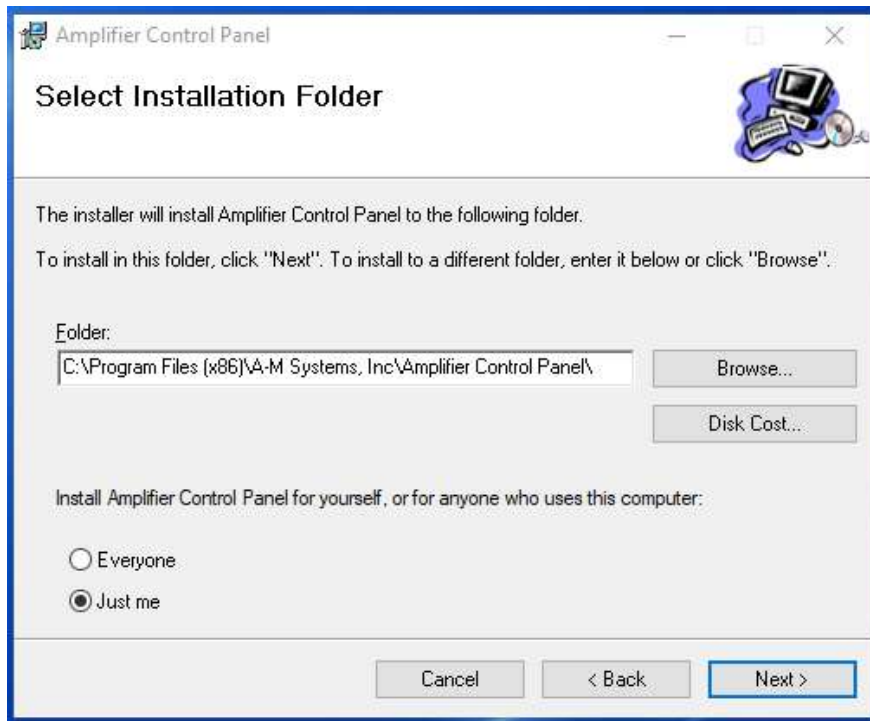

A question asks for who should be able to use the pc control software. Select “Everyone” and click “Next”

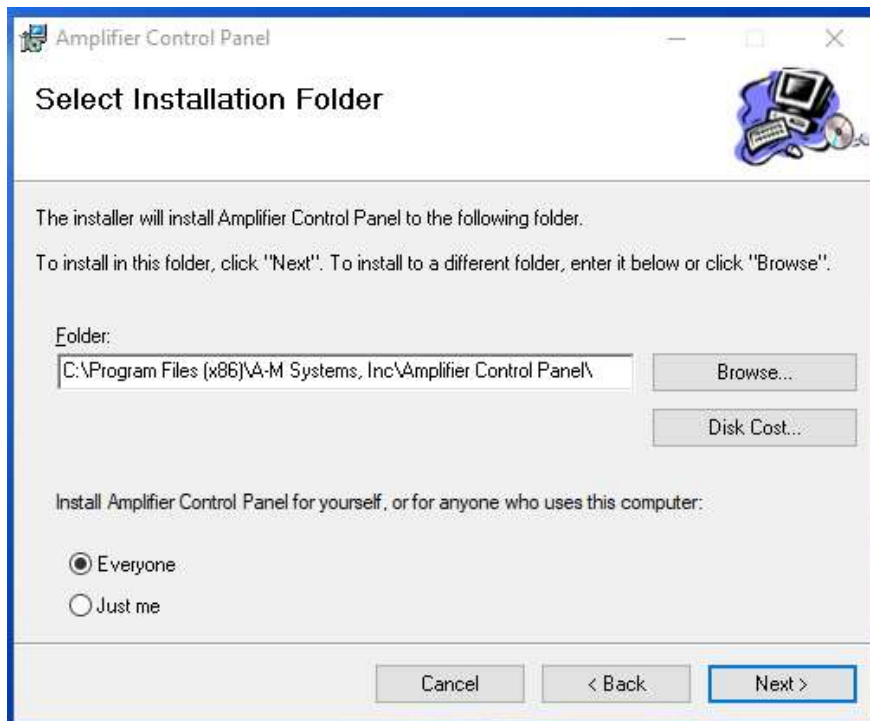

Confirm that you want to install the software by clicking “Next.”

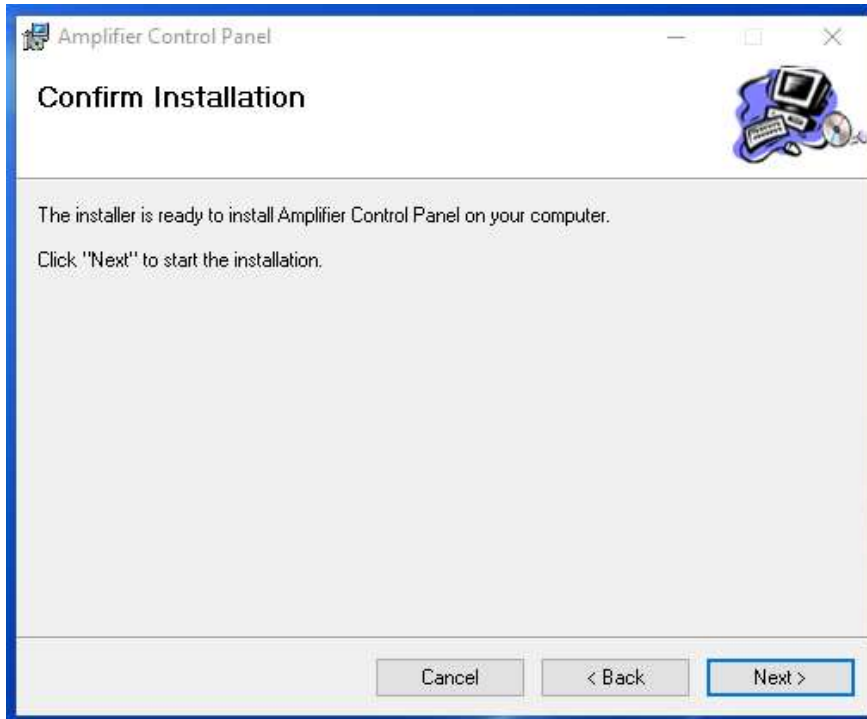

Once installation is complete, a final dialog box will be displayed: Press “Close” to exit.

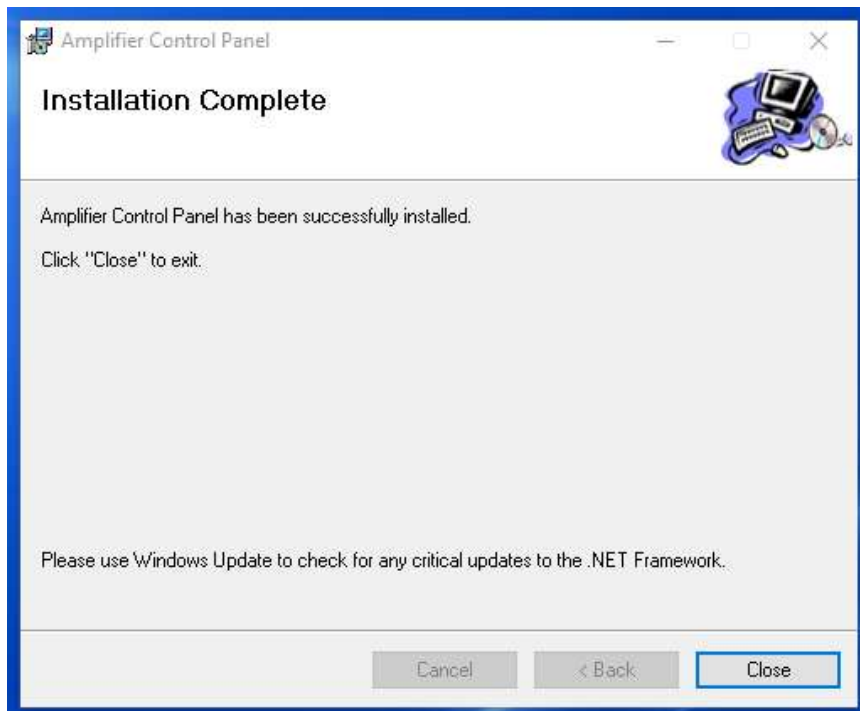

Using the Control Software

After the program has been installed, you can run it from the Start Menu by selecting Programs -> A-M Systems -> Amplifier Control Panel

Figure 32. PC Software

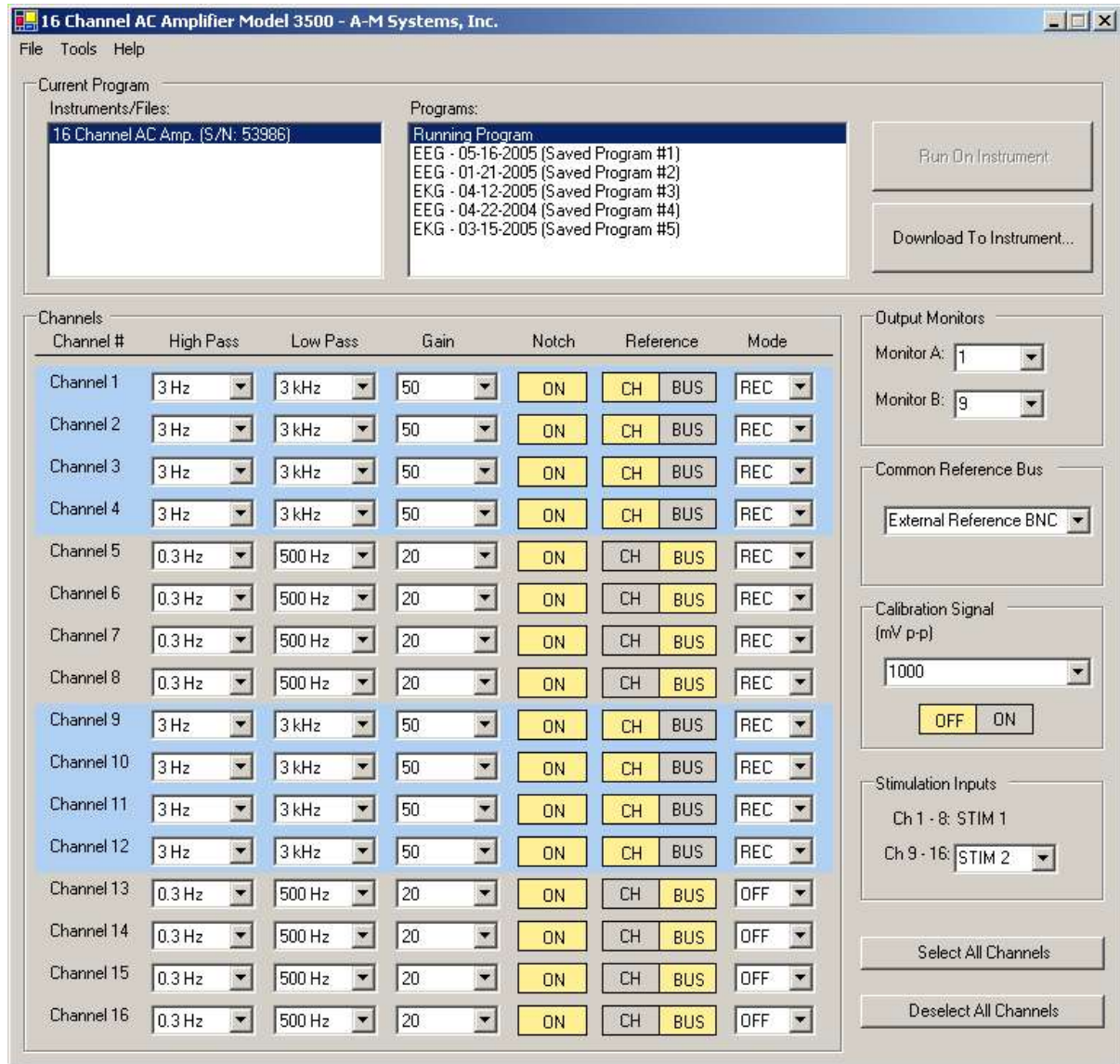

If your program loaded successfully, after a brief display of our company logo, the program window shown in Figure 32 should appear.

If the Model 3500 is turned on and attached to the computer when the control software is executed, then the instrument name and serial number should appear in the list located in the upper left corner of the main window under the heading INSTRUMENTS/FILES. If it is not listed, or if it is connected to the computer after the control software is started, select Refresh from the Instruments menu (or press F5) to refresh the list of available instruments. If you have multiple Model 3500s connected to the computer, each one will be listed by name and serial number in the list.

When an instrument is selected by clicking on its name, the computer takes control of the instrument's front panel interface preventing simultaneous manipulation of the amplifier settings. The instrument will continue to function in whatever state it was in prior to the computer taking control, and will do so until changes are made via the software program, or the "Touch Here to Take Control" button is pressed. When the "Touch Here" button is pressed, the instrument's front panel interface will assume control of the amplifiers, and the PC instrument control software will be temporarily disabled (The experiment log can still be used).

Figure 33. Instrument Screen when PC Program is in Control

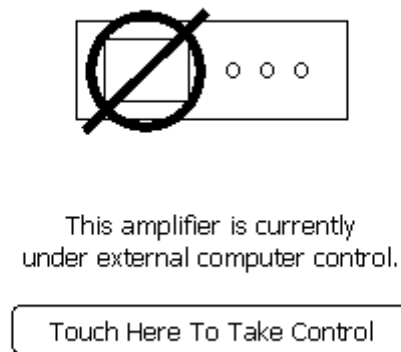

Viewing Programs on an Instrument

When an instrument is first selected (highlighted) in the list of INSTRUMENTS/FILES, the software will contact the instrument and retrieve a listing of the programs (complete parameter sets) stored on-board the selected Model 3500 and will list them under PROGRAMS. Highlighting an entry under programs will cause the software to download the values from the instrument and display them in the CHANNELS listings. This process of displaying settings stored on the instrument makes no changes to the active settings currently in use on the instrument. Specifically, it does not automatically load those values onto the Model 3500 highlighted under INSTRUMENTS/FILES.

Running Programs on an Instrument

To run the currently selected program on the instrument, click "RUN ON INSTRUMENT". To transfer a program to an instrument, highlight the source program and click "DOWNLOAD TO INSTRUMENT". The source program can be the running program of another instrument, a stored program on an instrument, or a data file from the computer.

Working with Computer Data Files

The FILE menu provides standard NEW, OPEN, SAVE, SAVE AS and CLOSE options for working with data files on your computer. Any data file which is currently open and highlighted in the INSTRUMENTS/FILES list can be run on an instrument or saved as a stored program on an instrument. Clicking SAVE AS while a running program or a stored program on an instrument is highlighted will cause the program settings to be saved as a data file on the computer.

Editing Program Settings

When an instrument is selected in the INSTRUMENTS/FILES list and the “Running Program” is selected in the PROGRAMS list, all changes to program parameters (including the CHANNELS settings, OUTPUT MONITORS, COMMON REFERENCE BUS, CALIBRATION SIGNAL, and STIMULATION INPUTS) are transferred immediately to the instrument and are implemented by the instrument. Changes made to computer files and programs stored on an instrument are not saved to disk or the instrument flash memory until explicitly saved using SAVE on the FILE menu or the DOWNLOAD TO INSTRUMENT button.

The CHANNELS display controls the individual parameter settings for each of the amplifier channels.

The OUTPUT MONITORS drop-down lists control which channel’s output is mirrored to the Model 3500’s front panel OUTPUT MONITOR BNCs.

The COMMON REFERENCE BUS setting controls whether the COMMON REFERENCE BUS is connected to the Amplifier Ground or to the External Reference BNC connector on the rear panel. In the CHANNELS area, the REF column determines whether each individual channel is connected to the common reference bus (BUS) or uses its individual channel reference inputs (CH). Selecting CH sets the channel to record differentially vs. its indifferent lead.

The CALIBRATION SIGNAL drop-down list sets the amplitude of the 1.0kHz sine wave available at the front panel CALIBRATION SIGNAL BNC connector for use in calibrating the instrument.

The STIMULATION INPUTS drop-down list determines if Channels 9-16 can receive stimulation signals from the rear panel STIM 2 BNC connector, or the rear panel STIM 1 BNC connector.

When the Model 3500 is under TTL control, the MODE settings in the control software will be ignored and the instrument will respond according to the TTL signal provided. All of the other settings will remain under the control of the computer software.

Experiment Log

As an added feature, an experiment log can be annotated during the experiment with current program settings and any notes that the user wants to enter. Under Tools, selecting Experiment Log will open a new dialog window. Either an existing log can be opened, or a new one started, using the commands under File in the new dialog window.

6. External TTL Control

The provided EXTERNAL TTL CONTROL on the Model 3500 rear panel enables the user to control the mode of any channel remotely. In order for the unit to respond to TTL inputs, pin 19, the unit's TTL ENABLE LINE, needs to be brought high by applying a voltage greater than 3 volts. When this happens, the voltage levels on the EXTERNAL TTL CONTROL signal lines (and not the settings on the touch screen or the computer control software) determine the channel MODE settings. A TTL icon will appear at the top of the LCD and will remain on as long as the TTL CONTROL line is high, and the unit is under external TTL control. Note that when under TTL control, the default condition is that all channels will go into record mode.

Figure 34. Toolbar with TTL Icon



Table 2 lists the TTL State table for controlling MODE. Table 3 lists the pin assignments for the rear panel External TTL connector.

Table 2. TTL State Table for controlling MODE.

TTL ENABLE (Pin 19)	MASTER BLANK ENABLE	CHANNEL BLANK ENABLE	CHANNEL STIM ENABLE	MODE	SUBJECT LEADS CONNECTED TO	AMPLIFIER LEADS CONNECTED TO
0	0	X	X	No Rear Panel Control	Depends on channel setting determined by touch screen / PC program settings	
1	0	0	0	Recording	Amplifier inputs	Subject leads
1	0	X	1	Stimulating	Stimulation Bus	Ground
1	0	1	0	Channel Blanked	Open (No Connection)	Ground
X	1	X	X	All Channels Blanked	Open (No Connection)	Ground

Legend

- 0: Voltage less than 2.0 V
- X: Voltage on pin does not matter
- 1: Voltage greater than 3.0V.

Figure 35. Diagram of External TTL Connector Pin Layout

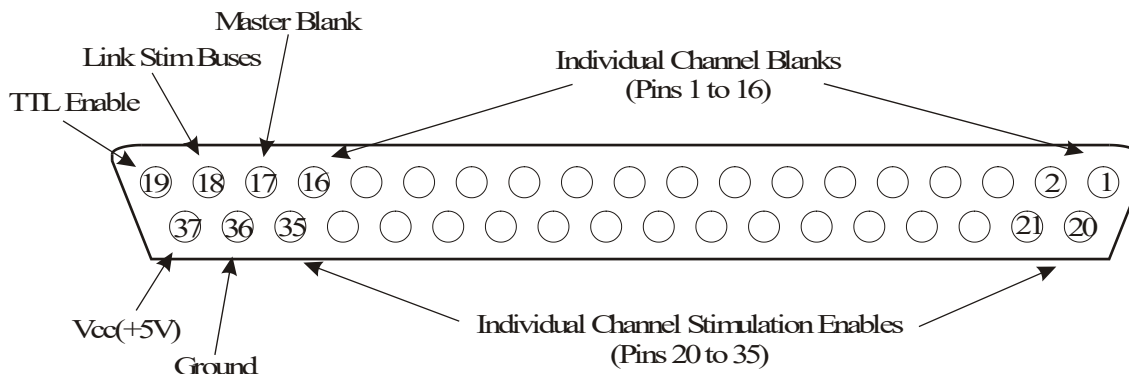

Table 3. External TTL Connector Pin Assignments

Pin Number	Function
1	Blank Enable Channel 16
2	Blank Enable Channel 15
3	Blank Enable Channel 14
4	Blank Enable Channel 13
5	Blank Enable Channel 12
6	Blank Enable Channel 11
7	Blank Enable Channel 10
8	Blank Enable Channel 9
9	Blank Enable Channel 8
10	Blank Enable Channel 7
11	Blank Enable Channel 6
12	Blank Enable Channel 5
13	Blank Enable Channel 4
14	Blank Enable Channel 3
15	Blank Enable Channel 2
16	Blank Enable Channel 1
17	Master Blank Enable
18	Link Stimulation Buses
19	TTL Control Enable

Pin Number	Function
20	Stimulation Enable Channel 16
21	Stimulation Enable Channel 15
22	Stimulation Enable Channel 14
23	Stimulation Enable Channel 13
24	Stimulation Enable Channel 12
25	Stimulation Enable Channel 11
26	Stimulation Enable Channel 10
27	Stimulation Enable Channel 9
28	Stimulation Enable Channel 8
29	Stimulation Enable Channel 7
30	Stimulation Enable Channel 6
31	Stimulation Enable Channel 5
32	Stimulation Enable Channel 4
33	Stimulation Enable Channel 3
34	Stimulation Enable Channel 2
35	Stimulation Enable Channel 1
36	Ground
37	Vcc (5V)

Master Blank Input

When a voltage greater than 3 volts is applied to this BNC, all 16 amplifier channels will blank (disconnect the subject signal leads from the channel amplifier and ground the channel inputs), regardless of the signal level on pin 19, the unit's TTL ENABLE LINE. When this channel is at ground (0V), all channels will be in record mode (signal input connected to the amplifier, and the channel output no longer grounded) unless the individual channel's blanking circuit is activated by either the front panel touch screen control or the rear panel TTL inputs.

7. Specifications

Noise:	0.7 μ V rms maximum (10Hz-10kHz)
Offset Voltage	
Input:	± 0.3 mV typical
Average Drift:	± 8.0 μ V/Deg C typical
Initial Bias Current:	± 3 pA typical
Input Offset Current:	± 3 pA typical
Input Impedance:	$10^{12} \Omega \parallel 50$ pF
Inter-channel Crosstalk:	100dB at 1kHz
Common Mode Rejection (CMR):	100dB
Rated Output	
Voltage:	± 11 V
Current:	5mA
High Pass Filter	
Cut-Off Frequencies (Hz):	0.3, 1.0, 3.0, 10.0, 30.0, 100, 300, 500
Cut-Off Rate:	40dB / decade
Low Pass Filter	
Cut-Off Frequencies (kHz):	0.1, 0.3, 0.5, 1.0, 3.0, 5.0, 10.0, 20.0
Cut-Off Rate:	40dB / decade
Gain	2, 4, 10, 20, 50, 100, 200, 500, 1,000, 2,000, 5,000, 10,000, 20,000
Notch Filter	
Frequency:	50Hz or 60Hz (User Selected)
Rejection:	>30dB
Calibration Signal	
Frequency	1kHz sine wave,
Amplitude	1, 10, 100 or 1000mVp-p

8. Warranty

A-M SYSTEMS, LLC

What does this warranty cover?

A-M Systems, LLC (hereinafter, “A-M Systems”) warrants to the Purchaser that the Instruments manufactured by A-M Systems (hereinafter the “hardware”), and sold after June 1, 2025, is free from defects in workmanship or material under normal use and service for 5 years from date of purchase. Headstages manufactured by A-M Systems and sold after June 1, 2025, will be repaired under warranty only once per year. This warranty commences on the date of delivery of the hardware to the Purchaser.

For hardware sold prior to June 1, 2025, the warranty in effect at time of purchase applies.

What are the obligations of A-M Systems under this warranty?

During the warranty period, A-M Systems agrees to repair or replace, at its sole option, without charge to the Purchaser, any defective component part of the hardware provided that the defective part can be purchased from mainstream, common, electronic component distributors such as Digi-Key Electronics, Newark, or Mouser Electronics. To obtain warranty service, the Purchaser must return the hardware to A-M Systems or an authorized A-M Systems distributor in an adequate shipping container. Any postage, shipping and insurance charges incurred in shipping the hardware to A-M Systems must be prepaid by the Purchaser, and all risk for the hardware shall remain with Purchaser until A-M Systems takes receipt of the hardware. Upon receipt, A-M Systems will promptly repair or replace the defective unit and then return the hardware (or its replacement) to the Purchaser with postage, shipping, and insurance prepaid by the Purchaser. A-M Systems may use reconditioned or like-new parts or units at its sole option, when repairing any hardware. Repaired products shall carry the same amount of outstanding warranty as from original purchase. Any claim under the warranty must include a dated proof of purchase of the hardware covered by this warranty. In any event, A-M Systems liability for defective hardware is limited to repairing or replacing the hardware.

What is not covered by this warranty?

This warranty is contingent upon proper use and maintenance of the hardware by the Purchaser and does not cover batteries. Neglect, misuse whether intentional or otherwise, tampering with or altering the hardware, damage caused

LIMITED WARRANTY, cont

by accident, damage caused by unusual physical, electrical, chemical, or electromechanical stress, damage caused by failure of electrical power, or damage caused during transportation are not covered by this warranty. Further, no guarantee is made regarding software compatibility with future updated operating systems. Products may not be returned to A-M Systems for service, whether under warranty or otherwise, which are contaminated by infectious agents, radioactive compounds or other materials constituting a health hazard to employees of A-M Systems

What are the limits of liability for A-M Systems under this warranty?

A-M Systems shall not be liable for loss of data, lost profits or savings, or any special, incidental, consequential, indirect or other similar damages, whether arising from breach of contract, negligence, or other legal action, even if the company or its agent has been advised of the possibility of such damages, or for any claim brought against you by another party.

THIS EQUIPMENT IS NOT INTENDED FOR CLINICAL MEASUREMENTS USING HUMAN SUBJECTS.

A-M SYSTEMS DOES NOT ASSUME RESPONSIBILITY FOR INJURY OR DAMAGE DUE TO MISUSE OF THIS EQUIPMENT.

Jurisdictions vary with regard to the enforceability of provisions excluding or limiting liability for incidental or consequential damages. Check the provision of your local jurisdiction to find out whether the above exclusion applies to you.

This warranty allocates risks of product failure between the Purchaser and A-M Systems. A-M Systems hardware pricing reflects this allocation of risk and the limitations of liability contained in this warranty. The agents, employees, distributors, and dealers of A-M Systems are not authorized to make modifications to this warranty, or additional warranties binding on the company. Accordingly, additional statements such as dealer advertising or presentations, whether oral or written, do not constitute warranties by A-M Systems and should not be relied upon. This warranty gives you specific legal rights. You may also have other rights which vary from one jurisdiction to another.

THE WARRANTY AND REMEDY PROVIDED ABOVE IS IN LIEU OF ALL OTHER WARRANTIES AND REMEDIES, WHETHER EXPRESS OR IMPLIED. A-M SYSTEMS DISCLAIMS THE WARRANTIES OF MERCHANTABILITY AND FITNESS FOR A PARTICULAR USE, WITHOUT LIMITATION

A-M Systems,
Approved:

3500 Manual

DRW-5027905 Rev 7

Revision History

Rev	Date	Description
1	6/30/06	Initial Document Release
2	11/2/06	Swapped pins 14 and 16 on the ganged output pin description.
3	4/28/10	DCR 201200 Warranty information and company info
4	1/18/17	DCR 201985, 201996, 202287. Update computer installation.
5	1/18/19	DCR 202615. Update content, add content rev control
6	3/19/20	DCR 203316. Update Warranty
7	5/1/2025	DCR 204239. Update Warranty